

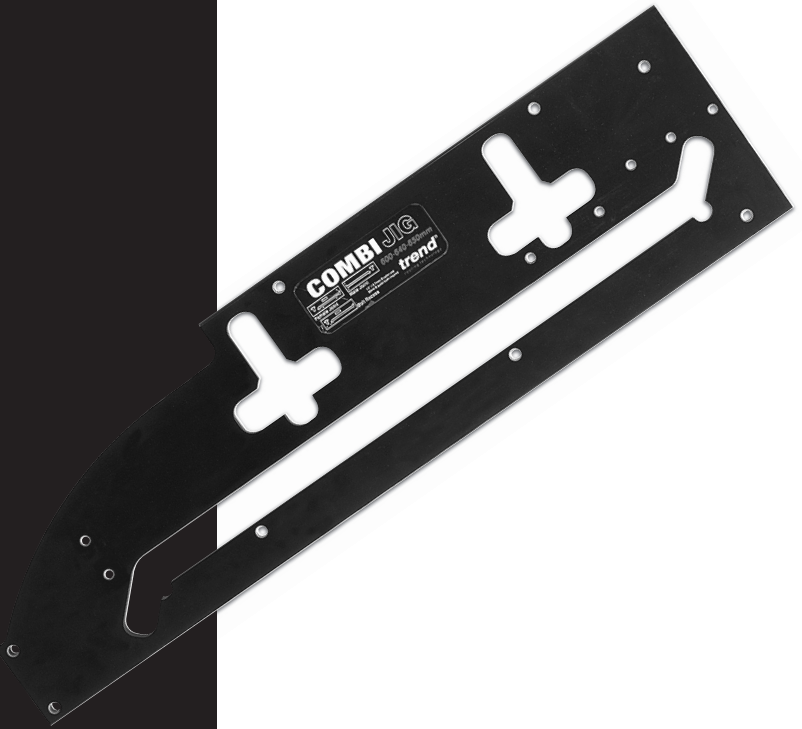

COMBI 66



trend[®]
routing technology

Dear Customer

Thank you for purchasing this Trend product, we hope you enjoy many years of creative and productive use.

Please remember to return your guarantee card within 28 days of purchase.

CONTENTS

TECHNICAL DATA	1
SAFETY	2-3
ITEMS ENCLOSED	4
DESCRIPTION OF PARTS	5
ACCESSORIES	
– Recommended Cutters	6
– Sub-base Sets & 30mm Guide Bush	6-7
– Panel Connector Bolts	8
– Biscuit Jointer for the Router & Clamp	8
– Carry Case	9
ASSEMBLY	
– Location Bush Identification	10
– Margin Distance	10
– Setting out the Joints	10
OPERATION	
– Setting the Length Stop	9
– Female Joint	9
– Male Joint	10
– Out-of-Square Joints	10
– Cutting the Bolt Recesses	11
– Strengthening the Joint	12
– Sealing the Joint	12
– Curved Peninsular	15
MAINTENANCE	15
ENVIRONMENTAL PROTECTION & GUARANTEE	15
SPARE PARTS	
– Spare Parts List	16
– Spare Parts Diagram	16
TROUBLE SHOOTING	1B

TECHNICAL DATA

Jig thickness	16mm
Cutter size	12.7mm
Workpiece thickness max.	45mm
Worktop width:	min. 580mm
	max. 650mm
Guide bush size	30mm
Weight	3.3kg

The following symbols are used throughout this manual:



Denotes risk of personal injury, loss of life or damage to the tool in case of non-observance of the instructions in this manual.



Refer to the instruction manual of your power tool.

This unit must not be put into service until it has been established that the power tool to be connected to this unit is in compliance with 2006/42 (identified by the CE marking on the power tool).

INTENDED USE

This jig is intended for use with a plunge router with suitbale guide bush and router cutter fitted to rout a kitchen joint in laminate covered particle board.



If you require further safety advice, technical information or spare parts, please call our technical support department on 01923 249911.

SAFETY



WARNING:

Observe the safety regulations in the instruction manual of the power tool to be used. Please read the following instructions carefully. Failure to do so could lead to serious injury. When using electric tools, basic safety precautions, including the following should always be followed to reduce the risk of fire, electric shock and personal injury. Also observe any applicable additional safety rules. Read the following safety instructions before attempting to operate this product.

PLEASE KEEP THESE INSTRUCTIONS IN A SAFE PLACE.

The attention of UK users is drawn to The Provision and Use of Work Equipment Regulations 1998, and any subsequent amendments.

Users should also read the HSE/HSC Safe Use of Woodworking Machinery Approved Code of Practice and Guidance Document and any amendments.

Users must be competent with woodworking equipment before using our products.

IMPORTANT NOTE:

Residual Risk. Although the safety instructions and operating manuals for our tools contain extensive instructions on safe working with power tools, every power tool involves a certain residual risk which cannot be completely excluded by safety mechanisms. Power tools must therefore always be operated with caution!

General

1. Disconnect power tool and attachment from power supply when not in use, before servicing, when making adjustments and when changing accessories such as cutters. Ensure switch is in "off" position. Always ensure cutter has stopped rotating.
2. Always mount the power tool, accessory or attachment in conformity with the instructions. Only use attachment and accessories specified in the power tool manual. The tool or attachment should not be modified or used for any application other than that for which it was designed. Do not force tool.
3. Keep children and visitors away. Do not let children or visitors touch the tool, accessory or attachment. Keep children and visitors away from work area. Make the workshop child proof with padlock and master switch.
4. Dress properly. Do not wear loose clothing or jewellery, they can be caught in moving parts. Rubber gloves and non-skid footwear is

recommended when working outdoors. Wear protective hair covering to contain long hair.

5. Consider working environment. Do not use the product in the rain or in a damp environment. Keep work area well lit. Do not use power tools near gasoline or flammable liquids. Keep workshop at a comfortable temperature so your hands are not cold. Connect machines that are used in the open via a residual current device (RCD) with an actuation current of 30 mA maximum. Use only extension cables that are approved for outdoor use.
6. The accessory or attachment must be kept level and stable at all times.
7. Keep work area clean. Cluttered workshops and benches can cause injuries. Ensure there is sufficient room to work safely.
8. Secure idle tools. When not in use, tools should be stored in a dry and high or locked up place, out of reach of children.
9. For best control and safety use both hands on the power tool and attachment. Keep both hands away from cutting area. Always wait for the spindle and cutter to stop rotating before making any adjustments.
10. Always keep guards in place and in good working order.
11. Remove any nails, staples and other metal parts from the workpiece.
12. Maintain tools and cutters with care. Keep cutters sharp and clean for better and safer performance. Do not use damaged cutters. Follow instructions for lubricating and changing accessories. Keep handles dry, clean and free from oil and grease.
13. Maintain accessories. Do not use damaged accessories. Only use accessories recommended by the manufacturer.
14. Check damaged parts. Before operation inspect the attachment, the power tool, the cable, extension cable and the plug carefully for signs of damage. Check for alignment of moving parts, binding, breakage, mounting and any other conditions that may effect its operation. Have any damage repaired by an Authorised Service Agent before using the tool or accessory. Protect tools from impact and shock.
15. Do not use tool if switch does not turn it on or off. Have defective switches replaced by an Authorised Service Agent
16. Don't over reach. Keep proper footing and balance at all times. Do not use awkward or uncomfortable hand positions.
17. Don't abuse the cable. Never carry power tool or accessory by cord or pull it to disconnect from the socket. Keep cord from heat, oil and sharp edges. Always trail the power cord away from the work area.
18. Connect dust extraction equipment. If devices are provided for the connection of dust extraction and collection facilities, ensure these are connected and properly used.
19. Check all fixing and fastening nuts, bolts and screws on power tool, attachment and cutting tools before use to ensure they are tight and secure. Periodically check when machining over long periods.
20. Stay alert. Watch what you are doing. Use common sense. Do not operate tools when you are tired, under the influence of drugs or alcohol.
21. Personal Protective Equipment (PPE) for eye, ear and respiratory protection must be worn. All PPE must meet current UK and EU legislation.
22. Do not leave tools running unattended. Do not leave tool until it comes to a complete stop.
23. Always clamp workpiece being machined securely.
24. Only use cutting tools for woodworking that meet EN847-1/2 safety standards, and any subsequent amendments.
25. Vibration levels. Hand held power tools produce different vibration levels. You should always refer to the specifications and relevant Health & Safety Guide.

Routing Safety

1. Read and understand instructions supplied with power tool, attachment and cutter.
2. Keep hands, hair and clothing clear of the cutter.
3. Remove adjusting keys and spanners. Check to see that keys and adjusting spanners are removed from the router tool, cutter and attachment before turning router on. Make sure cutter can rotate freely.
4. Noise. Take appropriate measures for the protection of hearing if the sound pressure of 85dB(A) is exceeded. Routing sound pressure may exceed 85dB(A), so ear protection must be worn.
5. Eye protection. Always wear eye protection in the form of safety goggles, spectacles or visors to protect the eyes.

6. Respiratory protection. Wear a face or dust mask, or powered respirator. Dust masks/filters should be changed regularly.
7. Do not switch router on with the cutter touching the workpiece. At the end of the cut, release the router plunge and allow spindle to stop rotating. Never use the spindle lock as a brake
8. The direction of routing must always be opposite to the cutter's direction of rotation. Do not back-cut or climb-cut.
9. Check before cutting that there are no obstructions in the path of the router. Ensure there are no obstacles beneath workpiece when cutting full thickness, and that a sacrificial work surface is used.

Router Cutter Safety

1. Cutting tools are sharp. Care should be taken when handling them. Do not drop cutters or knock them against hard objects. Handle very small diameter cutters with extra care. Always return cutter to its packaging after use.
2. Always use cutters with a shank diameter corresponding to the size of the collet installed in your tool.
3. The maximum speed (n.max) marked on the tool, or in instructions or on packaging shall not be exceeded. Where stated the speed range shall be adhered to. Recommended speeds are shown in the Trend Routing Catalogue and/or website.
4. Always use router cutters in a router. Drill and boring bits must not be used in a router. Router cutters must only be used for the material cutting application for which they are designed. Do not use on metal or masonry.
5. Never use cutters with a diameter exceeding the maximum diameter indicated in the technical data of the powertool or attachment used.
6. Before each use check that the cutting tool is sharp and free from damage. Do not use the cutting tool if it is dull, broken or cracked or if in any other damage is noticeable or suspected.
7. Cutters should be kept clean. Resin build up should be removed at regular intervals with Resin Cleaner[®]. The use of a PTFE dry lubricant will reduce resin build up. Do not use PTFE spray on plastic parts.
8. When using stacked tooling (multi-blade, block and groover etc.) on a spindle arbor, ensure that the cutting edges are staggered to each other to reduce the cutting impact.
9. Cutter shanks should be inserted into the collet all the way to the line

indicated on the shank. This ensures that at least ¾ of the shank length is held in the collet. Ensure clamping surfaces are cleaned to remove dirt, grease, oil and water.

10. Observe the correct assembly and fitting instructions in the router instruction manual for fitting the collet, nut and cutter.
11. Tool and tool bodies shall be clamped in such a way that they will not become loose during operation. Care shall be taken when mounting cutting tools to ensure that the clamping is by the shank of the cutting tool and that the cutting edges are not in contact with each other or with the clamping elements.
12. It is advisable to periodically check the collet and collet nut. A damaged, worn or distorted collet and nut can cause vibration and shank damage. Do not over-tighten the collet nut
13. Do not take deep cuts in one pass; take several shallow or light passes to reduce the side load applied to the cutter and router. Too deep a cut in one pass can stall the router.
15. In case of excessive vibrations whilst using the router stop immediately and have the eccentricity of the router, router cutter and clamping system checked by competent personnel
15. All fastening screws and nuts should be tightened using the appropriate spanner or key and to the torque value provided by the manufacturer.
16. Extension of the spanner or tightening using hammer blows shall not be permitted.
17. Clamping screws shall be tightened according to instructions provided by the manufacture. Where instructions are not provided, clamping screws shall be tightened in sequence from the centre outwards.

Using Routers In A Fixed Position

1. Attention should be made to the HSE's Safe Use of Vertical Spindle Moulding Machines Information Sheet No.18 and any revisions.
2. After work, release the router plunge to protect the cutter.
3. Always use a push-stick or push-block when making any cut less than 300mm in length or when feeding the last 300mm of the cut.
4. The opening around the cutter should be reduced to a minimum using suitably sized insert rings in the table and closing the back fence cheeks or fitting a false fence on the back fence.
5. Whenever possible use a work holding device or jig to secure

component being machined. Ensure any attachment is securely fitted to the workbench, with table surface at approximately hip height.

6. Use a No-Volt Release Switch. Ensure it is fixed securely, easily accessible and used correctly.
7. In router table (inverted) mode, stand to the front right of the table. The cutter will rotate anti-clockwise when viewed from top so the feed direction is from the right (against the rotation of the cutter). In overhead mode, stand to the front left of the machine table and the feed direction is from the left.
8. Do not reach underneath table or put your hands or fingers at any time in the cutting path while tool is connected to a power supply.
9. Never thickness timber between the back of the cutter and the backfence.

Useful Advice When Routing

1. Judge your feed rate by the sound of the motor. Feed the router at a constant feed rate. Too slow a feed rate will result in burning.
2. Trial cuts should be made on waste material before starting any project.
3. When using some attachments e.g. a router table or dovetail jig, a fine height adjuster is recommended.
4. When using a template guide bush, ensure there is sufficient clearance between cutter tip and inside edge of bush and that it cannot come into contact with collet and nut. Ensure cutter and guide bush are concentric.

Router Cutter Repair/Maintenance

1. Repair of tools is only allowed in accordance with the manufacturers instructions.
3. The design of composite (tipped) tools shall not be changed in process of repair. Composite tools shall be repaired by a competent person i.e. a person of training and experience, who has knowledge of the design requirements and understands the levels of safety to be achieved.
4. Repair shall therefore include, e.g. the use of spare parts which are in accordance with the specification of the original parts provided by the manufacturer.
5. Tolerances which ensure correct clamping shall be maintained.
6. Care shall be taken that regrinding of the cutting edge will not cause weakening of the body and the connection of the cutting edge to the body.

**ITEMS
ENCLOSED**

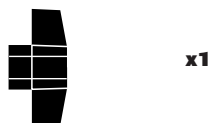
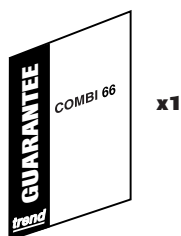
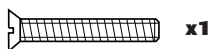
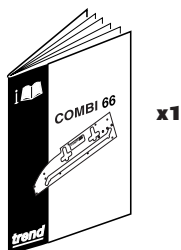
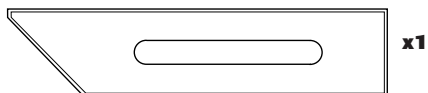
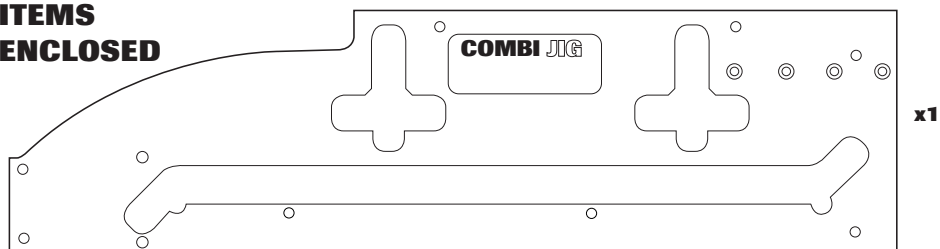

ITEMS REQUIRED

- 1/2" plunge router.
- 30mm guide bush.
- 12.7 diameter x 50mm cut router cutter with 1/2" shank.
- Trestle x 2.
- 100mm throat clamp x 2.
- Hand tools.
- Panel connector bolts.
- Wooden biscuits size No.20.
- Sealant.

**DESCRIPTION
OF PARTS**

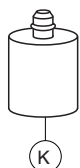
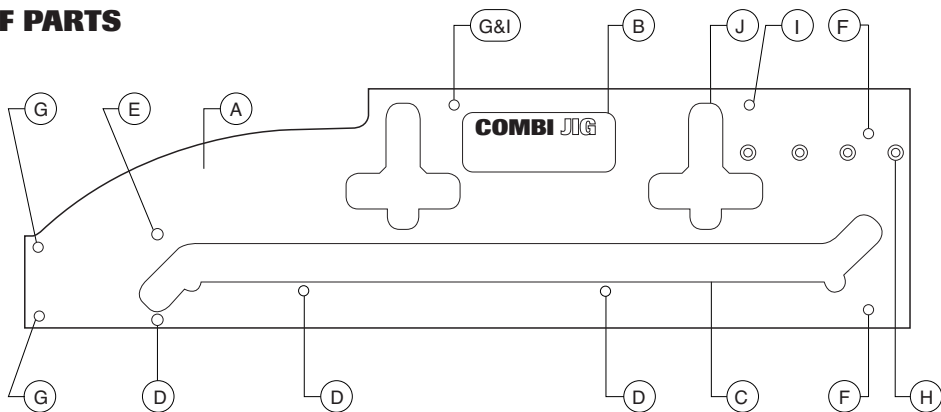

K

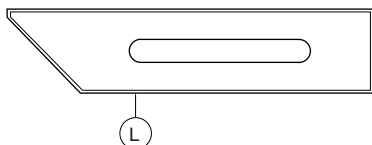

L



M

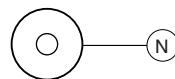

N

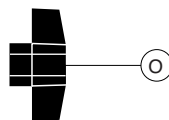

O

- (A) Jig body
- (B) Label
- (C) Postform joint slot
- (D) Female joint bush location hole
- (E) Length setting stop location hole
- (F) Male joint bush location hole
- (G) Peninsular joint bush location hole
- (H) Length stop fixing holes
- (I) Bolt recess bush location hole
- (J) Connecting bolt recess slot
- (K) Alloy location bush
- (L) Length setting stop
- (M) Length setting stop bolt
- (N) Length setting stop washer
- (O) Length setting stop knob

ACCESSORIES

Recommended Cutters

A 12.7mm (1/2") diameter cutter must be used, which has a 50mm cutting reach and plunge cut facility. Router must be plunged in stages of maximum 8mm in one pass.

Ref. 3/83X1/2TC, 3/83DX1/2TC, TR17X1/2TC, TR17DX1/2TC, C153X1/2TC, C153DX1/2TC



Ref. RT/11X1/2TC

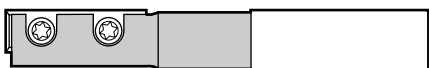

Description
RT/11 Spare blades

Order Ref.
RB/A (1 off)
RB/A/10 (10 off)

Ref. RT/13X1/2TC

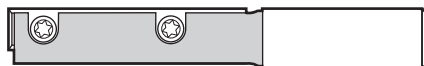

Description
RT/13 Spare blades

Order Ref.
RB/H (1 off)
RB/H/10 (10 off)

Sub-base Sets

To obtain a perfect accurate close fitting joint, a 30mm guide bush must be used. The guide bush must always be fitted concentric with the cutter. This can be achieved using Trend sub-bases and 30mm outside diameter guide bush ref. GB30.

Trend sub-bases have a central recess to allow fitting of the Trend guide bush to most makes of routers and are available ready to fit the most popular makes.

Two types are offered GB/5 and UNIBASE.

All sub-bases contain screws, a line up bush and pin. The line up pin and bush ensure exact alignment of sub-base with router spindle, when fitted with the relevant collet.

Ref. UNIBASE

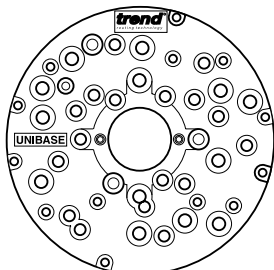

Fits following router models

Atlas Copco OFSE2000 Bosch GOF 1300ACE, 1600A, 1700ACE Casals FT2000VCE DeWalt DW625EK, 629 Draper R1900V Elu MOF 31, 77, 98, 131, 177(E) Felisatti TP246(E), R346EC Festo OF2000E Freud FT2000E Hitachi M12V, M12SA, TR12 Makita 3612BR, 3612(C) Metabo OF1612, OFE1812 Performance Pro CLM1250R >11/2003, CLM2050R Ryobi RE600N, R600N, RE601, R500, R502 Skil 1875U1 T-TECH TT/R127 Wadkin R500

Description
Universal sub-base

Order Ref.
UNIBASE

Ref. GB/5



**General instructions for fitting
Sub-bases to Router**

1. Fit line up guide bush onto sub-base, with screws supplied.
2. Fit 12.7mm (1/2") shank line up pin into collet of router. Plunge router until pin projects through base and lock plunge.
3. Locate guide bush and sub-base assembly over protruding pin.
4. Line up fixing holes and fit screws.
5. Now tighten up screws.
6. Remove line up bush and line up pin. Alignment should now be correct. Fit 30mm guide bush and cutter.
7. Periodically check the sub-base is concentric to the spindle of the router.

30mm Guide Bush

Ref. GB30



Fits following Router Models

Description	Order Ref.
Elu MOF31,77,98,131,177(E), Bosch GOF1600A & 1700ACE DeWalt DW625EK, 629 Performance Pro CLM2050R, CLM1250R >11/2003 Felisatti R346EC, TTECH TTR127	GB/5
Makita 3612BR & 3600B Ryobi RE600N & R600N, RE601	GB/5/A
Hitachi M12V, M12SA & TR12	GB/5/D
Makita 3612C & 3612	GB/5/J
Flex OFT3121VV, 2926W Portercable 7539, 7519, 7529, 97529	GB/5/M
Performance Pro CLM1250R <11/2003	GB/5/P
Triton TRB001	GB/5/Q
Felisatti TP246(E) Festo OF2000E, Mafell L065E, Metabo OF1612 & OFE1812, Ryobi R500 & R502, Skil 1875U1, Wadkin R500 & Nutool XP12	GB/5/S*

***Please state model when ordering.**

Description	Order Ref.
30mm guide bush to fit sub-base	GB30

Panel Connector Bolts

- Ref. PC/10/M (Pack of 10)
- Ref. PC/50/M (Pack of 50)
- Ref. PC/100/M (Pack of 100)
- Ref. PC/1000/M (Pack of 1000)

Panel butt connectors are essential for connecting worktops. They fit into the recess on the underside of the worktop and are tightened with a 10mm spanner. The jig has integral bolt recess slots to allow the bolt recess to be cut in the underside of the worktop, using the standard router cutter. The recess is elongated to allow easy access for the spanner.

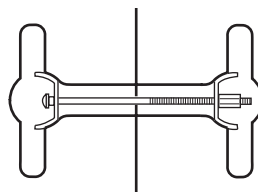

Biscuit Joiner for the Router

- Ref. 342X1/2TC
- Ref. TR35X1/2TC
- Ref. C152X1/2TC

Worktops with inadequate support below them need additional stability by biscuit jointing the edges. The biscuit jointing set for the router together with the No.20 biscuits will ensure worktops do not sag or warp in time.

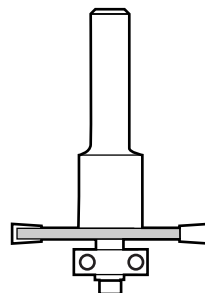

Flat Biscuit Dowels

- Ref. BSC/20/100 (Pack of 100 biscuits)
- Ref. BSC/20/1000 (Pack of 1000 biscuits)

Biscuits are used to strengthen the joint. When used with PVA glue they expand ensuring a tight joint.

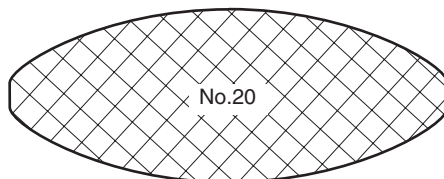

Clamps

- Ref. FC/200

Two heavy duty quick action or gripper clamps are required to secure the jig to the worktop.



Two heavy duty quick action or gripper clamps with throats of at least 100mm (4") are required to secure the jig to the worktop. Whenever fast action clamps are used, ensure they do not foul the router path and that they are securely tightened.

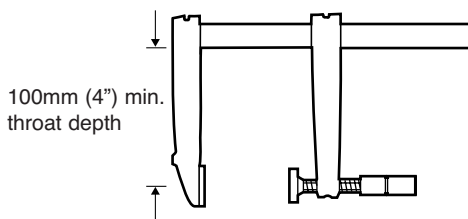

Carry Case

Hard wearing carry case to protect and allow ease of carrying of the COMBI66 Jig.

Description

Carry Case for COMBI66

Order Ref.

CASE/66

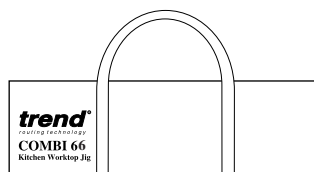

ASSEMBLY

Location Bush Identification

Three location bushes are used in different holes in the jig to align the correct template aperture for the application.

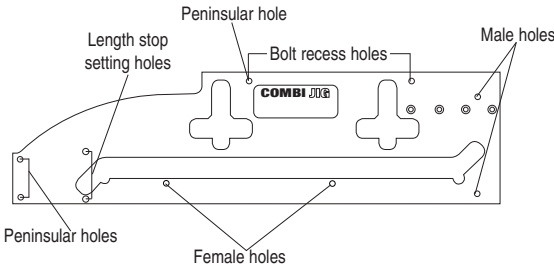

Margin Distance

Allow 8.5mm when cutting joints. Measure or use a batten of this thickness to aid setting out.

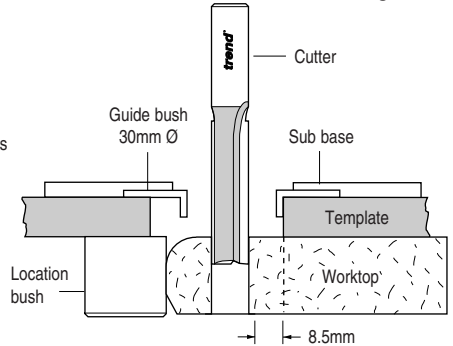

Location bushes are held in position by 'O' rings. Insert the smallest end of the bush into the hole by lightly pushing and turning at the same time. If the bushes are tight use a lubricant on the 'O' ring. Ensure bushes are fully home before use. When using jig ensure location bushes do not foul workbench.

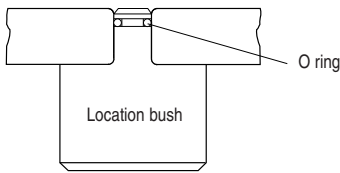

Setting out the Joints

When cutting a joint ensure location bushes contact the postformed edge of the worktop. For certain joints the worktop will need to be inverted so that all cuts are made into the postformed edge, never out through it. When routing worktop the balancing paper on the underside may feather edge – this feather edge should be removed with abrasive paper.

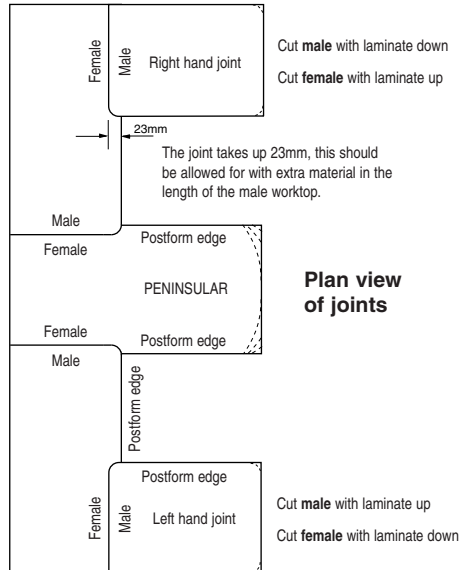

In order to prevent breakout of the laminate, rotation of the cutter and feed direction must always be into the postform edge of the worktop.

OPERATION



Setting the Length Stop for the Female Joint

Carry out the setting operation first:

- Fit bushes into length stop setting holes and offer the jig to the male worktop as shown. The label will be uppermost.
- Position the jig across the width of the male worktop. Loosely fit the length stop.
- Fasten length stop to template so that it traps the template across the worktop between the male location bushes and the stop. Tighten up the knob.
- Remove the bushes from male location hole. The template is now set to cut the correct length of joint for the female cut.

Female Joint



- Fit two location bushes in female holes as shown. (The label must be uppermost.) Leave the length stop bush in position.
- Place the template onto the female worktop to be cut, ensuring the location bushes are touching the worktop. Now clamp securely in position using two quick action clamps ensuring they will not foul the router path.
- Set cutter depth.
- Plunge router and cut joint in a series of passes, feeding left to right. At the end of the cut release plunge.



When cutting a joint, hold the router guide bush hard against the template and cut from left to right. It is recommended that the depth stops of the router are used to set the depths of cut. Several shallow passes of the router should be made and it is not necessary to lean heavily on the router or the jig. Allow the weight of the router to rest on the part of the template which is resting on the worktop. Ensure router remains parallel and upright at all times.

Setting the Length Stop

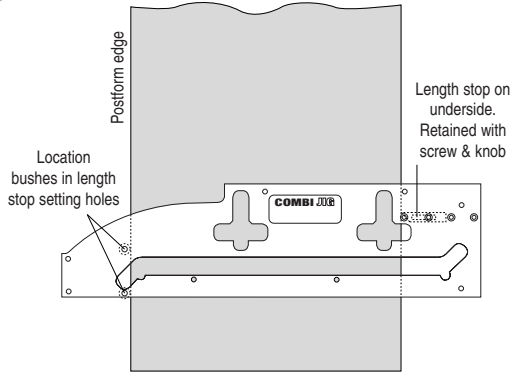

Length Stop Arrangement

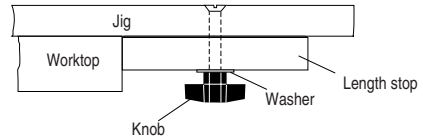

Routing the female part of the Joint

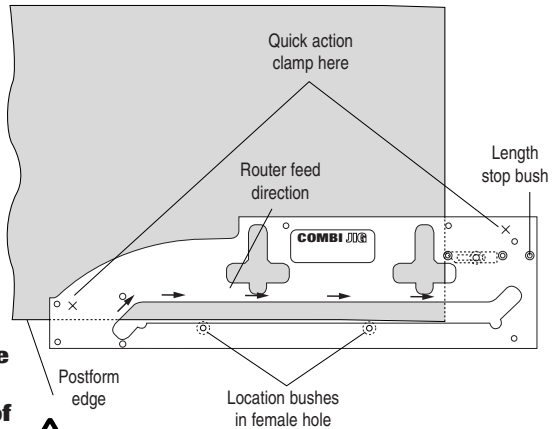

The edge of the jig slot that is not used is notched to act as a visual guide.



Set the length stop using the worktop width for the male cut, as this may be different to the female worktop width.

Male Joint 

Depending on accessibility lay female worktop into position on units. Lay male worktop on top and support other end. Using a pencil draw round the female cut onto the male from underside. If inaccessible lay female onto male. Depending on a right or left hand joint, the pencil line may need to be transferred on to the other side. Due to the difference between the cutter and the guide bush diameters, the cutter path will be 8.5mm over from the edge of the template, therefore either measure 8.5mm or use a packing piece of this size to offset the template by this amount to ensure the cutter cuts along the pencil line.

The postformed edge of the worktop must always be in contact with the location bushes, this means that to cut a male right hand joint, the worktop must be inverted. Remembering to cut into the postformed edge.

- Insert two location bushes into male holes as shown, label facing down.
- Place template across the width of the worktop and clamp securely to worktop.
- Set cutter depth. Plunge router and cut the male joint before finally cutting the work-top to length. A series of passes should be made feeding from left to right. At the end of the cut release plunge.

Out-of-square Joints (max 3°) 

Only the male cut needs to be adjusted if an out-of-square joint is required. On out-of-square joints there is a possibility of the chipboard core of the worktop becoming exposed which will need to be hidden with sealant.

Depending on accessibility mark out an out-of-square joint, first lay the female board on the cupboard carcass in position. Next lay the male section of board on to the carcass and on top of the female section of the board. Support other end. Mark around the female joint onto the male section of board.

If inaccessible lay female onto male.

- Use only the one location bush in the male hole indicated.
- Swing the template to suit the angle required and clamp down.
- Remember to allow an 8.5mm gap between template and cutting line.

Routing the male part of the Joint 

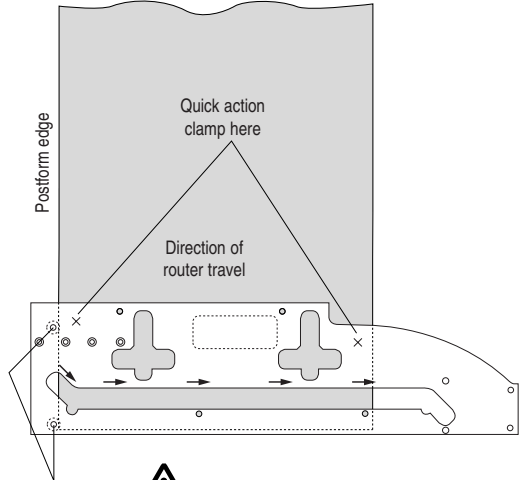

Test fit the joints together, abrasive paper may be required to clean up the chipboard core.

Cutting out-of-square male joint 

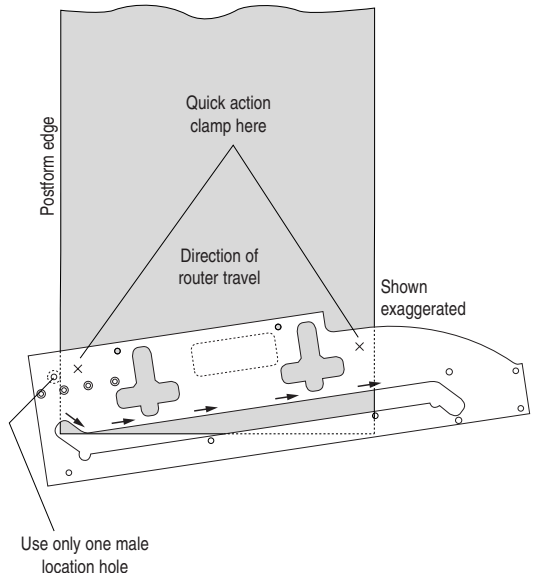

Cutting the Bolt Recesses 

When the joint has been tested, proceed as follows to cut the recess for panel butt connectors on the underside of the worktop. The same cutter and guide bush are retained and used with the integral bolt recess slots in the jig to produce the recesses for the panel butt connectors. The bolt recess position can be gauged approximately 150mm from the edge of the postform edge, or where access is possible with kitchen units. Mark with pencil both positions on the underside of the worktop.

Insert the location bushes into the bolt recess holes as shown.

- The template may need to be inverted when cutting some bolt recesses.
- Securely clamp jig to worktop.
- The bolt recesses should be approximately 22mm deep although this will depend upon the thickness of worktop.
- Once one bolt recess is cut move jig over to the remaining pencil lines and repeat.
- Repeat the procedure for the male joint.

Worktop Thickness	Depth Recess
30	22mm
40	28mm



Best results are achieved when the centre line of the bolt corresponds to the centre line of the worktop. Clamp jig securely to worktop.

Routing the bolt recess in the female part of the joint 

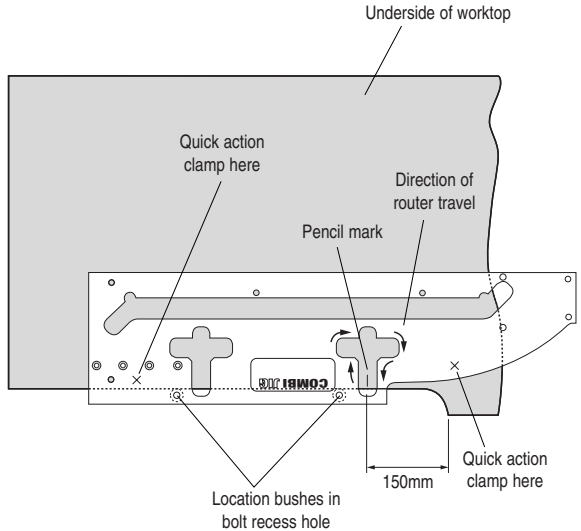

Routing the bolt recess in the male part of the joint 

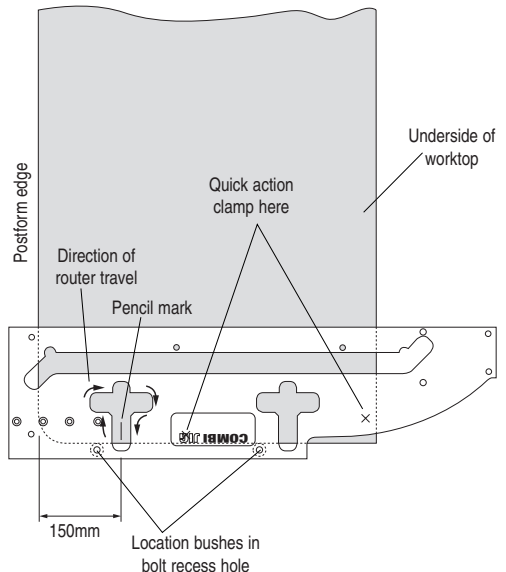

Strengthening the Joint



If the joint between the worktops is not supported underneath, after some time the joint may 'sag' and become misaligned; to reduce this the joint should be reinforced with a loose tongue or biscuit dowels. The biscuit jointing cutter set Trend Ref. 342, C152 or TR35 can be used with a portable router. The size of biscuit used should be No. 20.

Ref. BSC/20/100 (100 biscuits)

Ref. BSC/20/1000 (1000 biscuits)

A 650mm worktop should have at least 5 biscuits.

Sealing the Joint

The cut edges of the joint should be coated with a water-resistant adhesive, or Trend Fill & Seal[®] sealant before assembly, to prevent moisture seeping into the core of the worktops, which would swell, and disfigure the worktop

Cutter Ref. 342 shown

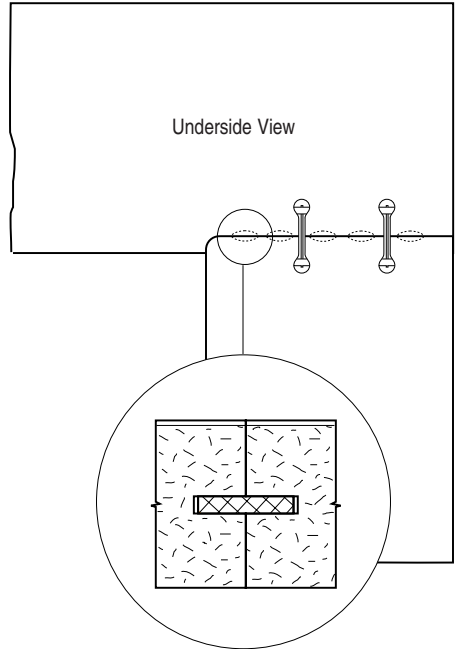
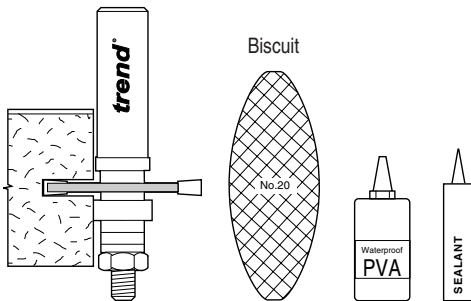

Curved Peninsular



Insert the three location bushes in the holes as shown.

Locate the template on the worktop as illustrated ensuring that location bushes are touching the worktop edge. Clamp into position with quick action clamps.

When cutting the curved peninsular, hold the router guide bush against the edge of the template. Cut from left to right.

It is recommended that depth stops are used and at least three or four cuts taken.

Routing the Curved Peninsular

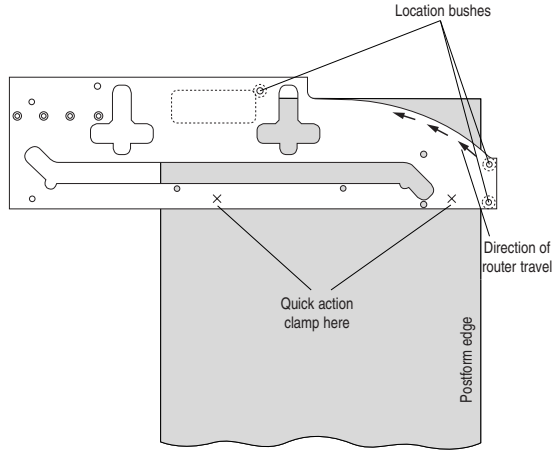

Peninsular End Cuts

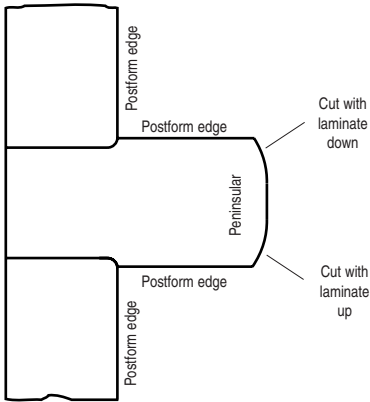

MAINTENANCE

The jig has been designed to operate over a long period of time with a minimum of maintenance. Continual satisfactory operation depends upon proper tool care and regular cleaning.

Cleaning

- Regularly clean the jig with a soft cloth.

Lubrication

- Your jig requires no additional lubrication.

ENVIRONMENTAL PROTECTION



Recycle raw materials instead of disposing as waste.

Packaging should be sorted for environmental-friendly recycling.

The product and its accessories at the end of their life should be sorted for environmental friendly recycling.

GUARANTEE

The jig carries a manufacturers guarantee in accordance with the conditions on the enclosed guarantee card.



In order to prevent break out of the laminate, rotation of the cutter and feed direction of the router must always be into the postform edge of worktop.

COMBI 66 - SPARE PARTS DIAGRAM

v1.0 04/2003

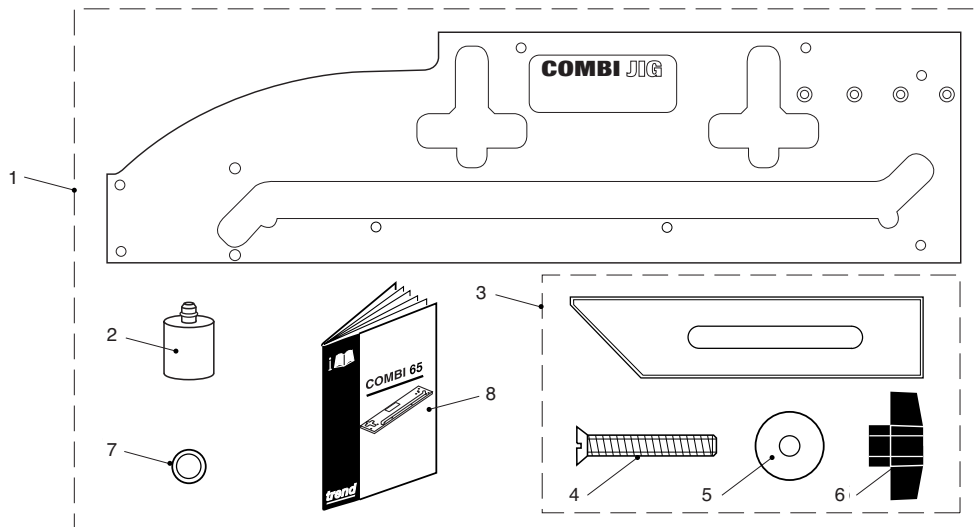

COMBI 66 - SPARE PARTS LIST			v1.0 04/2003
Item	Qty	Description	Ref.
1	0	Combi 66 Jig	COMBI/66
2	3	Alloy Bush	CJ/BUSH
3	1	Length Setting Stop Kit	CJ/LSK
4	0	Machine Screw Csk M8 x 50mm Slot	WP-SCW/41
5	0	Washer 8.5mm x 32mm x 6.0mm	WP-WASH/17
6	0	Knob M8	WP-KNOB/10
7	0	Combi Jig 'O' Ring Pack for Bushes (pack of 5)	CJ/ORS
8	1	Manual	MANU/66

TROUBLE SHOOTING

Fault	Cause	Remedy
■ Joint does not fit correctly at the radius.	Cutter or guide bush is the incorrect diameter or location bushes are not against worktop edge.	Check concentricity of cutter with guide bush. Cutter 12.7mm diameter with 30mm diameter guide bush. Ensure location bushes touch worktop.
■ The back edge of the joint does not line up.	Either the length stop or template was in the incorrect position, or the worktop has not pushed up against the length stop when the joint was cut.	Check position of length stop and re-cut joints.
■ When clamped together the joint has irregular gaps.	The guide bush has drifted away from the edge of the template whilst cutting either part of the joint, or wood chips in particle board have torn slightly.	Check with a straight edge which part of the joint is uneven and re-cut (this can only be done on the male cut) ensuring that the guide bush is kept against the template by machining from left to right. Use abrasive paper to remove torn wood chips.
■ Chipped laminate	Can be caused by a blunt cutter or removing too much material at one pass or exiting out of postform edge.	Always use sharp cutters and when cutting through the laminate cut 3–4mm of material. Maintain correct feed direction, to ensure cutter enters postform edge.
■ Jig slipping on material	Clamps not secure or too deep a cut being made or cutter is blunt.	Check clamps for wear. Clamp securely, take shallow passes, use a sharp cutter.
■ Cut joints not square	Router has tilted or operator has leaned heavily on router causing jig flex.	Ensure jig is supported and do not push hard on router taking shallow passes. Ensure weight of router is on supported part of jig and that the router is upright.
■ Assembled joint not flush or bowed	Worktop different thickness or worktop not flat (cupped).	Ensure worktop is same thickness and flat.

MANU/66 v4.0



RECYCLABLE

Trend Machinery & Cutting Tools Ltd.

Odhams Trading Estate St Albans Road
Watford WD24 7TR England

Tel: 0044(0)1923 249911
technical@trendm.co.uk

www.trend-uk.com