

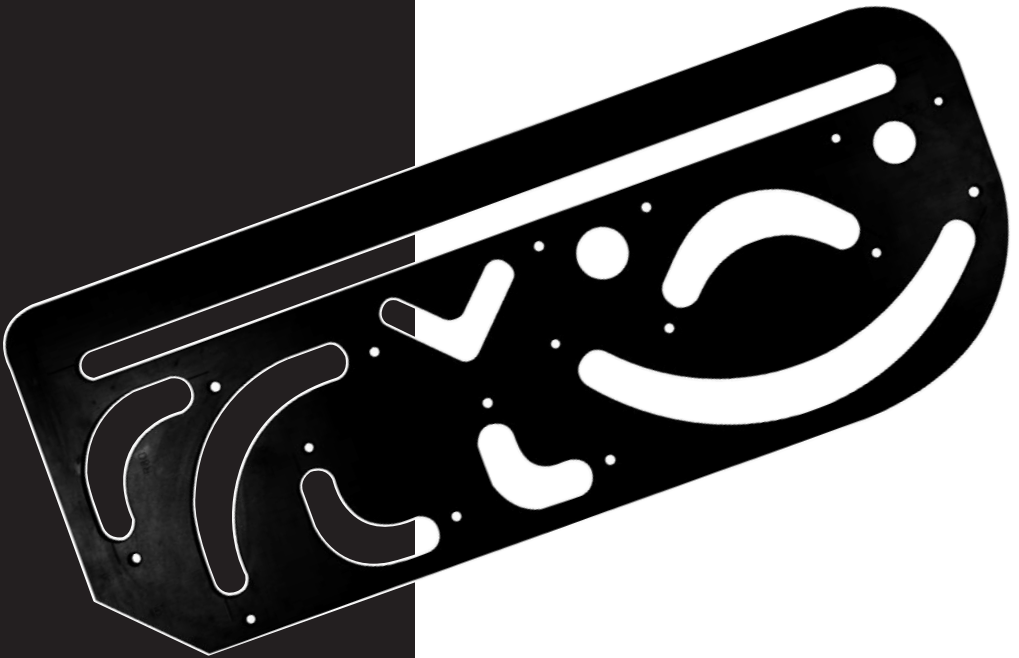

AR/JIG



trend[®]
routing technology



Please read these instructions before use.

Dear Customer

Thank you for purchasing this Trend product, we hope you enjoy many years of creative and productive use.

Please remember to return your guarantee card within 28 days of purchase.

CONTENTS

TECHNICAL DATA _____	1
SAFETY _____	2-3
ITEMS ENCLOSED _____	4
DESCRIPTION OF PARTS _____	4
ACCESSORIES	
– Recommended Cutters _____	5
– Sub-base Set, 30mm Guide Bush _____	5
– Clamps _____	5
ASSEMBLY	
– Location Pin Identification _____	6
– Margin Distance _____	6
– Sight Lines _____	7
TYPES OF CUT _____	7
OPERATION	
– HOB/SINK APERTURE _____	8-12
– Marking out for Hob/Sink Aperture _____	8-9
– Setting Up for Internal Radii _____	10
– Routing Internal Radii _____	10
– Setting Up Internal 90° Cut _____	11
– Routing Internal 90° Cut _____	11
– Setting Up Internal Straight Cut _____	12
– Routing Internal Straight Cut _____	12
– EDGE CUTS _____	13-14
– Setting Up for External Radii _____	13
– Routing External Radii _____	13
– 45° Angle Cut _____	14
– Corner Radius R50mm to R200mm _____	14
– CIRCULAR HINGE RECESS _____	15
MAINTENANCE _____	15
ENVIRONMENTAL PROTECTION _____	15
GUARANTEE _____	15
SPARE PARTS	
– Spare Parts Diagram _____	IB
– Spare Parts List _____	IB

TECHNICAL DATA

Jig thickness	12mm
Cutter size	12.7mm
Workpiece thickness max.	45mm
Recess depth min.	300mm
Recess depth max.	830mm
Guide bush size	30mm
Weight	4.6kg

The following symbols are used throughout this manual:



Denotes risk of personal injury, loss of life or damage to the tool in case of non-observance of the instructions in this manual.



Refer to the instruction manual of your power tool.

This unit must not be put into service until it has been established that the power tool to be connected to this unit is in compliance with 2006/42/EC (identified by the CE marking on the power tool).

INTENDED USE

This jig is intended for use with a plunge router with suitable guide bush and router cutter fitted to rout recesses and apertures for sinks, hobs and corner radii in laminate covered particle board.



If you require further safety advice, technical information or spare parts, please call Trend Technical Support or visit www.trend-uk.com

SAFETY



WARNING:

Observe the safety regulations in the instruction manual of the power tool to be used. Please read the following instructions carefully. Failure to do so could lead to serious injury. When using electric tools, basic safety precautions, including the following should always be followed to reduce the risk of fire, electric shock and personal injury. Also observe any applicable additional safety rules. Read the following safety instructions before attempting to operate this product.

PLEASE KEEP THESE INSTRUCTIONS IN A SAFE PLACE.

The attention of UK users is drawn to The Provision and Use of Work Equipment Regulations 1998, and any subsequent amendments.

Users should also read the HSE/HSC Safe Use of Woodworking Machinery Approved Code of Practice and Guidance Document and any amendments.

Users must be competent with woodworking equipment before using our products.

IMPORTANT NOTE:

Residual Risk. Although the safety instructions and operating manuals for our tools contain extensive instructions on safe working with power tools, every power tool involves a certain residual risk which cannot be completely excluded by safety mechanisms. Power tools must therefore always be operated with caution!

General

1. Disconnect power tool and attachment from power supply when not in use, before servicing, when making adjustments and when changing accessories such as cutters. Ensure switch is in "off" position. Always ensure cutter has stopped rotating.
2. Always mount the power tool, accessory or attachment in conformity with the instructions. Only use attachment and accessories specified in the power tool manual. The tool or attachment should not be modified or used for any application other than that for which it was designed. Do not force tool.
3. Keep children and visitors away. Do not let children or visitors touch the tool, accessory or attachment. Keep children and visitors away from work area. Make the workshop child proof with padlock and master switch.
4. Dress properly. Do not wear loose clothing or jewellery, they can be caught in moving parts. Rubber gloves and non-skid footwear is recommended when working outdoors. Wear protective hair

covering to contain long hair.

5. Consider working environment. Do not use the product in the rain or in a damp environment. Keep work area well lit. Do not use power tools near gasoline or flammable liquids. Keep workshop at a comfortable temperature so your hands are not cold. Connect machines that are used in the open via a residual current device (RCD) with an actuation current of 30 mA maximum. Use only extension cables that are approved for outdoor use.
6. The accessory or attachment must be kept level and stable at all times.
7. Keep work area clean. Cluttered workshops and benches can cause injuries. Ensure there is sufficient room to work safely.
8. Secure idle tools. When not in use, tools should be stored in a dry and high or locked up place, out of reach of children.
9. For best control and safety use both hands on the power tool and attachment. Keep both hands away from cutting area. Always wait for the spindle and cutter to stop rotating before making any adjustments.
10. Always keep guards in place and in good working order.
11. Remove any nails, staples and other metal parts from the workpiece.
12. Maintain tools and cutters with care. Keep cutters sharp and clean for better and safer performance. Do not use damaged cutters. Follow instructions for lubricating and changing accessories. Keep handles dry, clean and free from oil and grease.
13. Maintain accessories. Do not use damaged accessories. Only use accessories recommended by the manufacturer.
14. Check damaged parts. Before operation inspect the attachment, the power tool, the cable, extension cable and the plug carefully for signs of damage. Check for alignment of moving parts, binding, breakage, mounting and any other conditions that may effect its operation. Have any damage repaired by an Authorised Service Agent before using the tool or accessory. Protect tools from impact and shock.
15. Do not use tool if switch does not turn it on or off. Have defective switches replaced by an Authorised Service Agent
16. Don't over reach. Keep proper footing and balance at all times. Do not use awkward or uncomfortable hand positions.
17. Don't abuse the cable. Never carry power tool or accessory by cord or pull it to disconnect from the socket. Keep cord from heat, oil and sharp edges. Always trail the power cord away from the work area.
18. Connect dust extraction equipment. If devices are provided for the connection of dust extraction and collection facilities, ensure these are connected and properly used.
19. Check all fixing and fastening nuts, bolts and screws on power tool, attachment and cutting tools before use to ensure they are tight and secure. Periodically check when machining over long periods.
20. Stay alert. Watch what you are doing. Use common sense. Do not operate tools when you are tired, under the influence of drugs or alcohol.
21. Personal Protective Equipment (PPE) for eye, ear and respiratory protection must be worn. All PPE must meet current UK and EU legislation.
22. Do not leave tools running unattended. Do not leave tool until it comes to a complete stop.
23. Always clamp workpiece being machined securely.
24. Only use cutting tools for woodworking that meet EN847-1/2 safety standards, and any subsequent amendments.
25. Vibration levels. Hand held power tools produce different vibration levels. You should always refer to the specifications and relevant Health & Safety Guide.

Routing Safety

1. Read and understand instructions supplied with power tool, attachment and cutter.
2. Keep hands, hair and clothing clear of the cutter.
3. Remove adjusting keys and spanners. Check to see that keys and adjusting spanners are removed from the router tool, cutter and attachment before turning router on. Make sure cutter can rotate freely.
4. Noise. Take appropriate measures for the protection of hearing if the sound pressure of 85dB(A) is exceeded. Routing sound pressure may exceed 85dB(A), so ear protection must be worn.
5. Eye protection. Always wear eye protection in the form of safety goggles, spectacles or visors to protect the eyes.
6. Respiratory protection. Wear a face or dust mask, or powered respirator. Dust masks/filters should be changed regularly.

7. Do not switch router on with the cutter touching the workpiece. At the end of the cut, release the router plunge and allow spindle to stop rotating. Never use the spindle lock as a brake
8. The direction of routing must always be opposite to the cutter's direction of rotation. Do not back-cut or climb-cut.
9. Check before cutting that there are no obstructions in the path of the router. Ensure there are no obstacles beneath workpiece when cutting full thickness, and that a sacrificial work surface is used.

Router Cutter Safety

1. Cutting tools are sharp. Care should be taken when handling them. Do not drop cutters or knock them against hard objects. Handle very small diameter cutters with extra care. Always return cutter to its packaging after use.
2. Always use cutters with a shank diameter corresponding to the size of the collet installed in your tool.
3. The maximum speed (n.max) marked on the tool, or in instructions or on packaging shall not be exceeded. Where stated the speed range shall be adhered to. Recommended speeds are shown in the Trend Routing Catalogue and/or website.
4. Always use router cutters in a router. Drill and boring bits must not be used in a router. Router cutters must only be used for the material cutting application for which they are designed. Do not use on metal or masonry.
5. Never use cutters with a diameter exceeding the maximum diameter indicated in the technical data of the powertool or attachment used.
6. Before each use check that the cutting tool is sharp and free from damage. Do not use the cutting tool if it is dull, broken or cracked or if in any other damage is noticeable or suspected.
7. Cutters should be kept clean. Resin build up should be removed at regular intervals with Resin Cleaner. The use of a PTFE dry lubricant will reduce resin build up. Do not use PTFE spray on plastic parts.
8. When using stacked tooling (multi-blade, block and groover etc.) on a spindle arbor, ensure that the cutting edges are staggered to each other to reduce the cutting impact.
9. Cutter shanks should be inserted into the collet all the way to the line indicated on the shank. This ensures that at least $\frac{3}{4}$ of the shank length is held in the collet. Ensure clamping

surfaces are cleaned to remove dirt, grease, oil and water.

10. Observe the correct assembly and fitting instructions in the router instruction manual for fitting the collet, nut and cutter.
11. Tool and tool bodies shall be clamped in such a way that they will not become loose during operation. Care shall be taken when mounting cutting tools to ensure that the clamping is by the shank of the cutting tool and that the cutting edges are not in contact with each other or with the clamping elements.
12. It is advisable to periodically check the collet and collet nut. A damaged, worn or distorted collet and nut can cause vibration and shank damage. Do not over-tighten the collet nut
13. Do not take deep cuts in one pass; take several shallow or light passes to reduce the side load applied to the cutter and router. Too deep a cut in one pass can stall the router.
14. In case of excessive vibrations whilst using the router stop immediately and have the eccentricity of the router, router cutter and clamping system checked by competent personnel
15. All fastening screws and nuts should be tightened using the appropriate spanner or key and to the torque value provided by the manufacturer.
16. Extension of the spanner or tightening using hammer blows shall not be permitted.
17. Clamping screws shall be tightened according to instructions provided by the manufacture. Where instructions are not provided, clamping screws shall be tightened in sequence from the centre outwards.

Using Routers In A Fixed Position

1. Attention should be made to the HSE's Safe Use of Vertical Spindle Moulding Machines Information Sheet No.18 and any revisions.
2. After work, release the router plunge to protect the cutter.
3. Always use a push-stick or push-block when making any cut less than 300mm in length or when feeding the last 300mm of the cut.
4. The opening around the cutter should be reduced to a minimum using suitably sized insert rings in the table and closing the back fence cheeks or fitting a false fence on the back fence.
5. Whenever possible use a work holding device or jig to secure component being machined. Ensure any attachment is securely fitted to the workbench, with table surface at

approximately hip height.

6. Use a No-Volt Release Switch. Ensure it is fixed securely, easily accessible and used correctly.
7. In router table (inverted) mode, stand to the front right of the table. The cutter will rotate anti-clockwise when viewed from top so the feed direction is from the right (against the rotation of the cutter). In overhead mode, stand to the front left of the machine table and the feed direction is from the left.
8. Do not reach underneath table or put your hands or fingers at any time in the cutting path while tool is connected to a power supply.
9. Never thickness timber between the back of the cutter and the backface.

Useful Advice When Routing

1. Judge your feed rate by the sound of the motor. Feed the router at a constant feed rate. Too slow a feed rate will result in burning.
2. Trial cuts should be made on waste material before starting any project.
3. When using some attachments e.g. a router table or dovetail jig, a fine height adjuster is recommended.
4. When using a template guide bush, ensure there is sufficient clearance between cutter tip and inside edge of bush and that it cannot come into contact with collet and nut. Ensure cutter and guide bush are concentric.

Router Cutter Repair/Maintenance

1. Repair of tools is only allowed in accordance with the manufacturers instructions.
2. The design of composite (tipped) tools shall not be changed in process of repair. Composite tools shall be repaired by a competent person i.e. a person of training and experience, who has knowledge of the design requirements and understands the levels of safety to be achieved.
3. Repair shall therefore include, e.g. the use of spare parts which are in accordance with the specification of the original parts provided by the manufacturer.
4. Tolerances which ensure correct clamping shall be maintained.
5. Care shall be taken that regrinding of the cutting edge will not cause weakening of the body and the connection of the cutting edge to the body.

Version 7.2 06/2013

ITEMS ENCLOSED

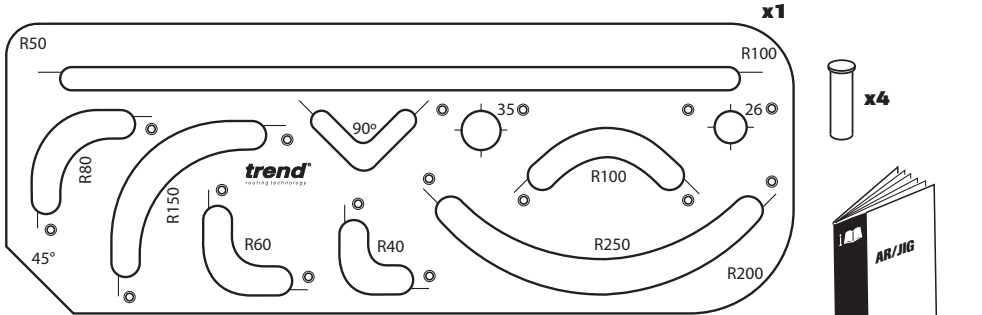

ITEMS REQUIRED

- 1/2" plunge router.
- 30mm guide bush.
- 12.7mm diameter x 50mm cut router cutter with 1/2" shank.
- Trestles x 2.
- Clamps x 2.
- Hand tools.

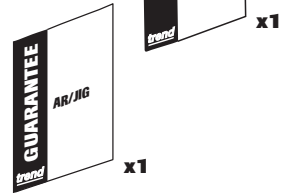

DESCRIPTION OF PARTS

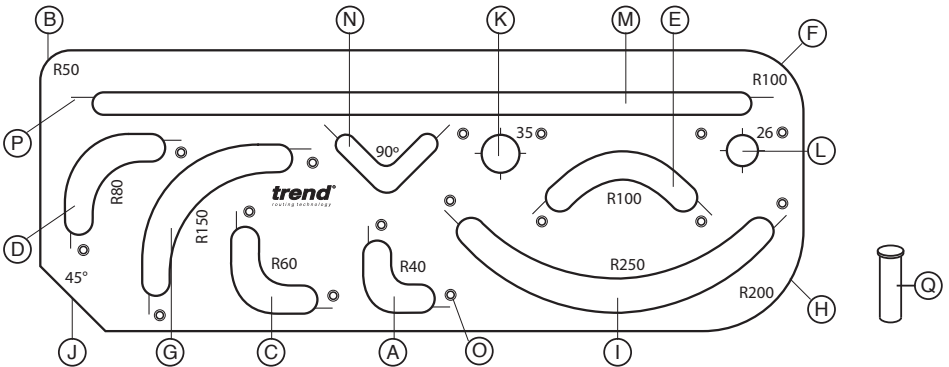

- (A) 40mm radius curve (Int & Ext)
- (B) 50mm radius curve (Ext)
- (C) 60mm radius curve (Int & Ext)
- (D) 80mm radius curve (Int & Ext)
- (E) 100mm radius curve (Int & Ext)
- (F) 100mm radius curve (Ext)
- (G) 150mm radius curve (Int & Ext)
- (H) 200mm radius curve (Ext)
- (I) 250mm radius curve (Int & Ext)
- (J) 45° corner
- (K) 35mm circular hinge recess
- (L) 26mm circular hinge recess
- (M) Straight slot
- (N) 90° corner cut (Int & Ext)
- (O) Pin holes
- (P) Engraved sight lines
- (Q) Pin

ACCESSORIES

Please use only Trend original accessories.

Recommended Cutters

A 12.7mm (1/2") diameter cutter must be used, which has a 50mm cutting reach and plunge cut facility. Router must be plunged in stages of maximum 8mm in one pass.

Ref. 3/83X1/2TC, 3/83DX1/2TC, TR17, TR17D, C153X1/2TC, C153DX1/2TC or RT/11X1/2TC

C153, C153D, TR17, TR17D, 3/83, 3/83D

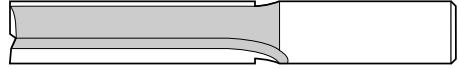

RT/11



Description
RT/11 Spare blades

Order Ref.
RB/A (1 off)
RB/A/10 (10 off)

Sub-base Set

Ref. UNIBASE

To obtain a perfect accurate close fitting joint, a 30mm guide bush must be used. The guide bush must always be fitted concentric with the cutter. This can be achieved using a Universal Sub-base and 30mm outside diameter guide bush ref. GB30.

The Sub-base fits to the most popular routers and contains screws, a line-up bush and two line up pins. The line up pins and bush ensure exact alignment of with the router spindle.

General Instructions for Fitting Sub-bases to Router

1. Fit line up guide bush onto sub-base, with screws supplied.
2. Fit 12.7mm (1/2") shank line up pin into collet of router. Plunge router until pin projects through base and lock plunge.
3. Locate guide bush and sub-base assembly over protruding pin.
4. Line up fixing holes and fit screws. Now tighten up screws.
5. Remove line up bush and line up pin. Alignment should now be correct. Fit 30mm guide bush and cutter.
6. Periodically check the sub-base is concentric to the spindle of the router.

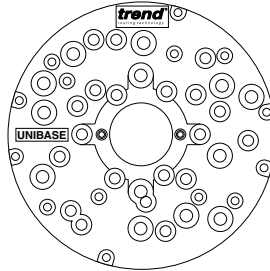

Fits following router models

Atlas Copco OFSE2000 Bosch GOF 1300ACE, 1600A, 1700ACE Casals FT2000VCE DeWalt DW625EK, 629 Draper R1900V Elu MOF 31, 77, 98, 131, 177(E) Felisatti TP246(E), R346EC Festo OF2000E Freud FT2000E Hitachi M12V, M12SA, TR12 Makita 3612BR, 3612(C) Metabo OF1612, OFE1812 Performance Pro CLM1250R >11/2003, CLM2050R Ryobi RE600N, R600N, RE601, R500, R502 Skil 1875U1 T-TECH TT/R127 Wadkin R500

30mm Guide Bush

Ref. GB30/A

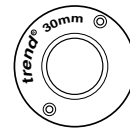

Clamps

Ref. FC/200

Two heavy duty quick action or gripper clamps are required to secure the jig to the worktop.



Whenever clamps are used, ensure they do not foul the router path and that they are securely tightened.

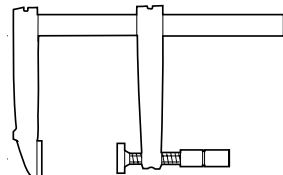

ASSEMBLY

Location Pin Identification

For external radii, two location pins are used in different holes in the jig to align the correct template aperture. The location pins are only used for external radii or for cutting kitchen circular hinge recess.

Location pins are tapered to ensure a good tight fit in hole. Insert the smallest end of the pin into the hole by lightly pushing. Ensure pins are fully home before use and head is below surface. When using jig ensure location pins do not foul workbench.

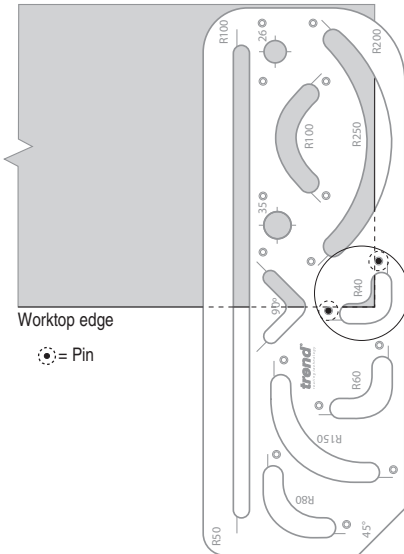
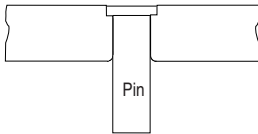

Care must be taken to ensure the offset between jig aperture and worktop edge is equal at each end so that the worktop is routed properly. This can be achieved by measuring and/or marking out. If the offset is not equal the worktop may result in a step being routed or a non-true radius/corner.

Margin Distance

Allow 8.5mm when cutting joints. Measure or use a batten of this thickness to aid setting out.

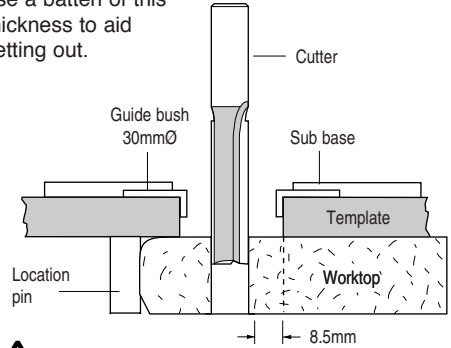

Ensure worktop is held securely to trestles. Ensure jig is clamped securely to worktop and placed at a comfortable work height.



Location pins are only used for external radii.

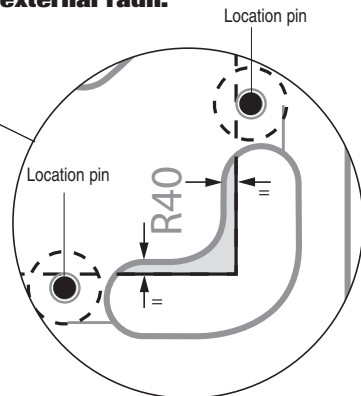

For external radii R40mm, R60mm, R80mm, R150mm the jig can be set parallel to the worktop edge. For external radii R100mm and R250mm and 90° cut the jig should be at 45° to the worktop edge.

Sight Lines

The jig is engraved with sight lines, these should be lined up with the actual outline drawn on the worktop. The sight lines allow for the cutter and guide bush offset. Ensure jig aperture and working edge is equal at each end to ensure the worktop is routed properly. Sight lines are used for internal cuts.

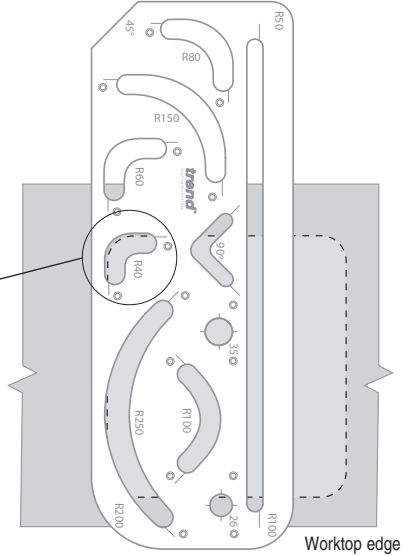
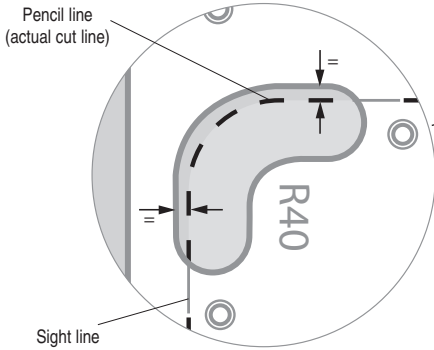

TYPES OF CUT

End Cuts



40mm Radius



50mm Radius



60mm Radius



80mm Radius



100mm Radius



150mm Radius



200mm Radius



250mm Radius



45° Corner

Sink & Hob Cut

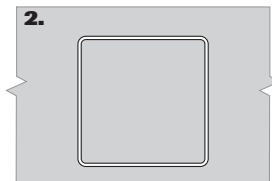
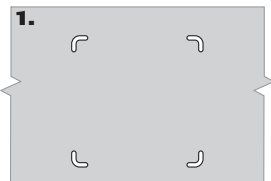

90° Radius/Corner & Straight Cuts

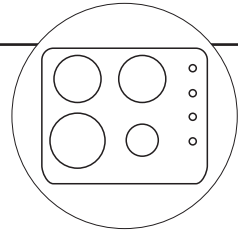

OPERATION



HOB/SINK APERTURE



Marking Out for Hob/Sink Aperture

Most sink and hob manufacturers installation instructions will give you the dimensions of the recess or aperture that needs to be cut to fit their particular appliance.

Measure and mark out these dimensions in the chosen position on your worktop. The pencil lines on the worktop will be used to line up the sight lines on the jig. Drawings show the R40mm internal radius being used.

Internal 40mm Corner Sequence

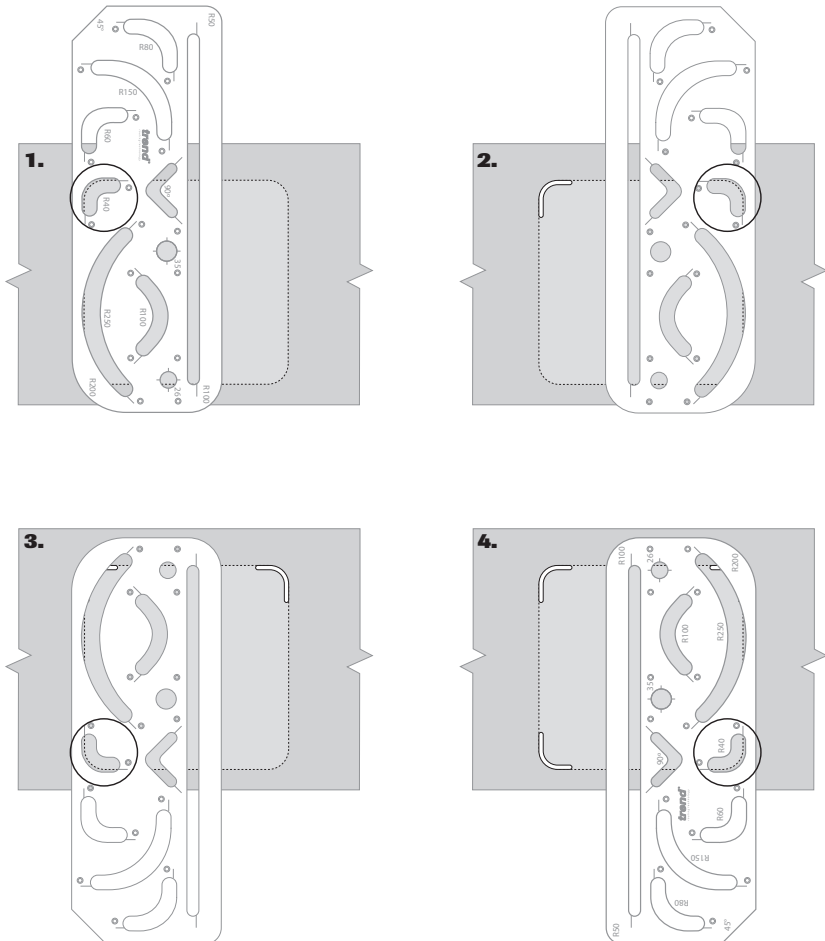

Special Note: If the manufacturers specifications are not available for the hob, place the hob onto the worktop and draw around it. Next draw a line offset inside your original line by 10-15mm to suit hob recess.

Internal Straight Cut Sequence

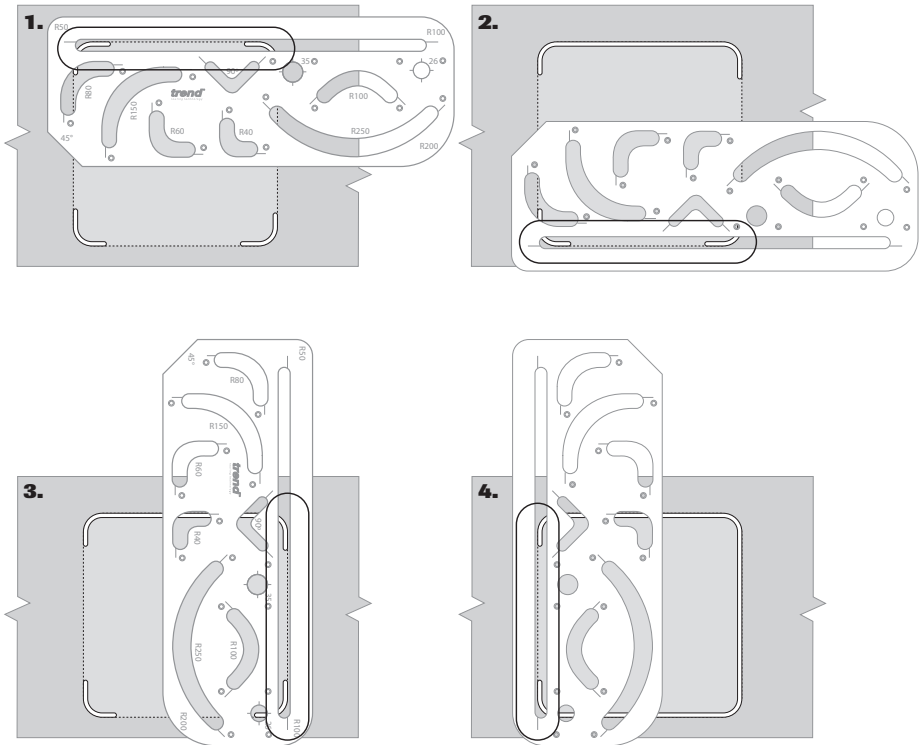

Setting Up for Internal Radii

- Mark out where the radii need to be on the worktop for the aperture hole you are cutting, i.e. how big the cut out for the hob is. Drawings show the R40mm Internal Radius being used.
- Select the radius you need and position the jig so that the engraved lines correspond with the markings you have made. Ensure jig edge is parallel to worktop edge.
- Secure the jig firmly in place with clamps.



The engraved lines should only be used for producing internal radii.

Routing Internal Radial Cut Part 1

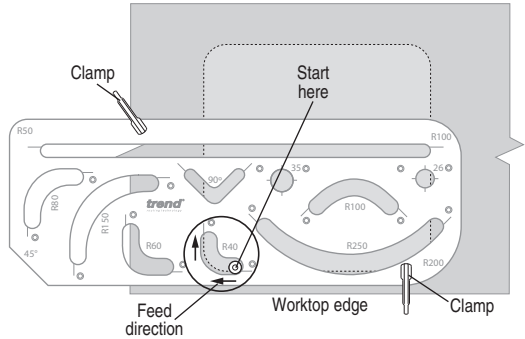

Routing Internal Radii



- Ensure router is fitted with correct size guide bush and router cutter.
- Set the depth of cut for 8-10mm for your first cut.
- Position the router on the left hand side of the slot.
- Switch on router and plunge cut and start the cut by pushing the router towards the edge with the corresponding lines opposite to the holes.
- Increase the depth of cut and repeat until the cutting is completed. At end of the cut, release the plunge and switch off router.
- Once all radii are cut, use the straight cut to join the radii using the engraved lines.



Ensure the router base plate will not foul the clamps.



Ensure worktop is held securely to trestles. Ensure jig is clamped securely to worktop and placed at a suitable and comfortable work height.

Routing Internal Radii Cut Part 2 etc.

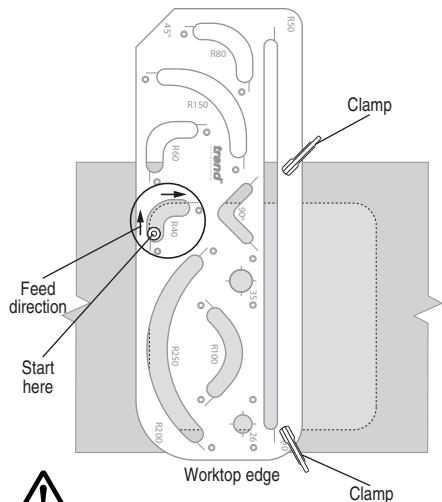

Release plunge on router at end of each cut.



Ensure working position is comfortable. Keep proper footing at all times.

Setting Up Internal 90° Cut

- Mark out where the 90 degree cuts need to be on the worktop for the aperture you are cutting, i.e. how big the cut out for the hob should be.
- Position the jig so that the engraved lines correspond with the markings you have made.
- Secure the jig firmly in place with clamps.

Routing Internal 90° Cut 

- Set the depth of cut for 8-10mm for your first cut.
- Position the router on the left hand side of the slot. Switch on router and plunge cut, start the cut by pushing the router along the jig slot edge.
- Increase the depth of cut and repeat until the cutting is completed. At end of the cut release the plunge and switch off router.
- Once all the 90 degree corners are cut use the straight cut to join the corners using the engraved lines as a set up guide.



Release plunge on router at end of each cut.



Ensure jig overhang is supported.

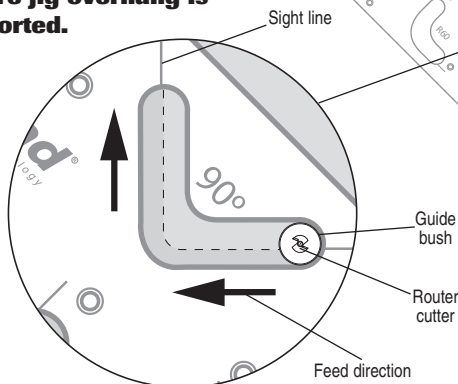

Routing Internal 90° Cut Part 1

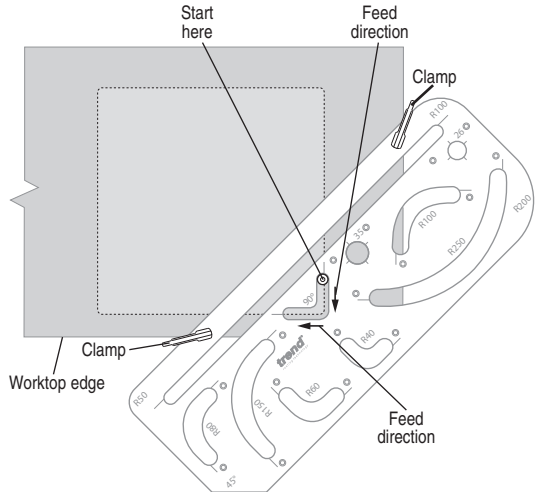

Routing Internal 90° Cut Part 2 etc.

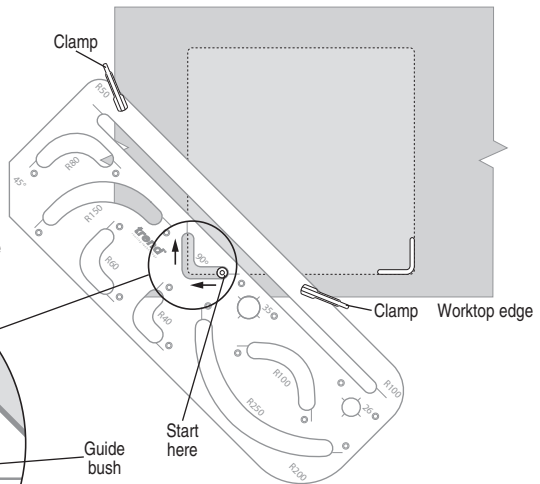

Periodically use a vacuum extractor to remove dust from jig apertures and work area.

Setting Up Internal Straight Cut

The internal straight cut is used to join the corners that were previously cut.

When routing the straight slot cut it is necessary to set the jig offset accordingly. The straight cut slot has engraved sight lines at each end but only one sight line can generally be used at a time for most cuts.

- Place the jig on the worktop, align one sight line to the edge of the routed slot and set the other end of the jig straight slot 8.5mm away from the other routed corner. This ensures the correct offset.
- Mark the length of cut required on the worktop.
- Secure the jig firmly in place with clamps.

Routing Internal Straight Cut



- Set the depth of cut for 8-10mm for your first cut.
- Position the router on the left side of the jig slot. Switch on router and plunge cut, start the cut by pushing the router along the jig slot edge. Ensure to stop at the correct length.
- Increase the depth of cut and repeat until the cutting is completed. At the end of the cut, reduce the plunge and switch off router.
- Follow this process for joining internal radius cuts for hob, sink cut outs.
- For hob, sink cut outs we recommend routing the radii first, then routing the straight cuts to join them. Ensure waste is supported.



For straight cuts, only part of the straight slot in the jig is used. Use user made stops or rout to a pencil line to limit slot length.



Ensure jig overhang is supported.

Routing Internal Straight Cut Part 1 & 3

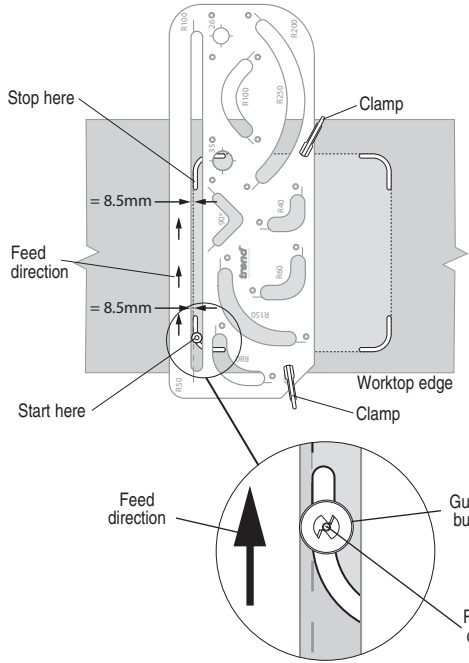

Routing Internal Straight Cut Part 2 & 4

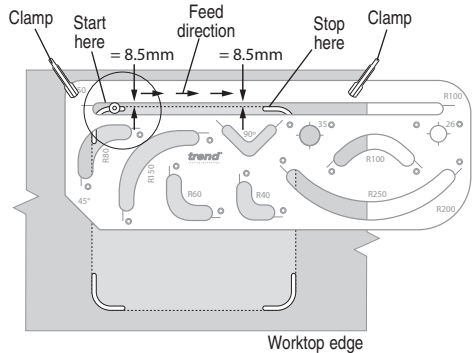

EDGE CUTS 

Setting Up for External Radii

- Choose which radius you want to use and place the two location pins in the appropriate holes.
- Position the jig, making sure the pins are pushed firmly against the worktop edges.
- R250 and R100 need to be set at 45 degrees to the worktop edge.
- R150, R80, R60 and R40 needs to be set parallel to worktop edge.
- Secure the jig firmly in place with clamps.



The location pins should only be used for producing external radii.



Care must be taken to ensure the offset between jig aperture and worktop edge is equal to each side to ensure the worktop is routed properly.

Routing External Radii 

- Set the depth of cut for 8-10mm for your first cut.
- Position the router on the left hand side of the slot and start cutting by pulling the router towards the edge with the corresponding hole opposite to the engraved lines.
- Increase the depth of cut and repeat until the cutting is completed.



In order to prevent breakout of the laminate, rotation of the cutter and feed direction must always be into the postform edge of the worktop.

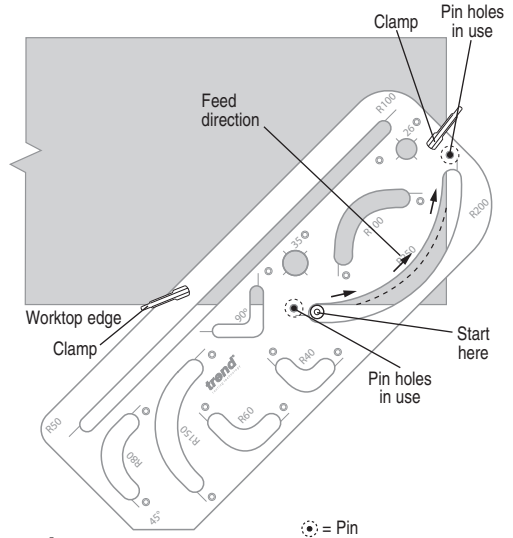

Release plunge on router at end of each cut.

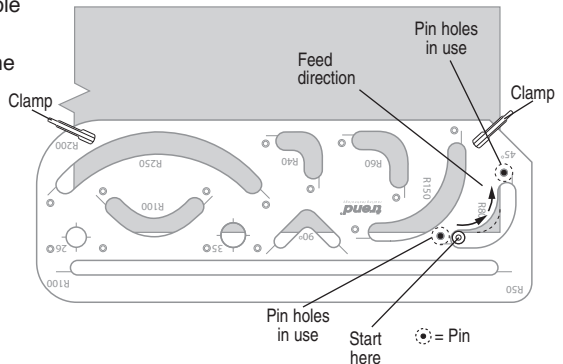

45° Degree Angle End Cut 

- Locate the jig on the worktop and line up by eye, ensuring the jig is laid at least 8.5mm in from the edges of the worktop to allow for the cutter and guide bush offset. Ensure jig edge is parallel to worktop edge.
- Secure the jig with clamps. It is recommended that the router depth stops are used and three or four cuts taken cutting from left to right.



In order to prevent break out of the laminate, rotation of the cutter and feed direction of the router must always be into the postform edge of the worktop.

Corner Radius R50mm, 100mm, 150mm or 200mm 

Special Note: Due to the nature of this cut, the corner radius will be more awkward to edge laminate.

- Locate the jig on the worktop and line up by eye, ensuring the jig is laid at least 8.5mm in from the edges of the worktop to allow for the cutter and guide bush offset. Ensure jig edge is parallel to worktop edge.
- Secure the jig with clamps.
- When cutting the radius hold the router guide bush against the template radius. Feed left to right. It is recommended that depth stops are used and three or four cuts are taken.



Ensure jig overhang is supported.



Ensure jig edge is parallel to worktop edges.

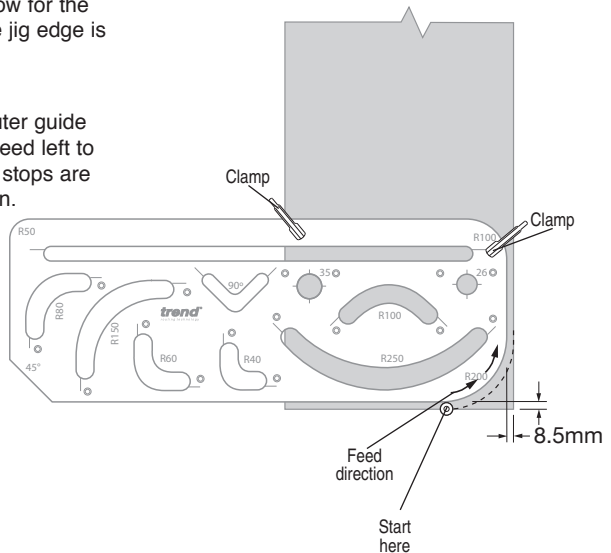
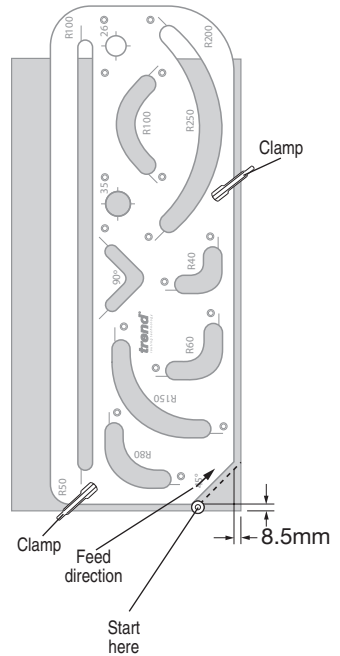

CIRCULAR HINGE RECESS

Routing 26mm & 35mm Circular Hinge Recesses

- Mark the position of the hinge on the door. The centre of the holes should be roughly 100mm from the top of the door to give the required support, ensure this measurement is as accurate as possible.
- Position two pins in the holes marked in the diagram.
- Position the jig as shown in the diagram with the two pins pushed up against the edge of the door. Ensure jig edge is parallel to door edge.
- Secure the jig with clamps.
- Set the depth for 10mm.
- Commence cutting of the recess making sure to clean out the material in the centre of the hole as well as round the edge.
- Repeat operation increasing the cut by 1mm, therefore setting the total depth for 11mm. (This should be enough clearance for most hinges. Adjust this measurement if you require holes for thicker hinge heads).

After use, store jig carefully.

MAINTENANCE

Please use only Trend original spare parts and accessories.

The jig has been designed to operate over a long period of time with a minimum of maintenance. Continual satisfactory operation depends upon proper tool care and regular cleaning.

Cleaning

- Regularly clean the jig with a soft cloth.

Lubrication

- Your jig requires no additional lubrication.

Storage

- After use, store jig in its packaging or it can be hung on a wall hook.
- An accessory case is available Ref. CASE/1001.

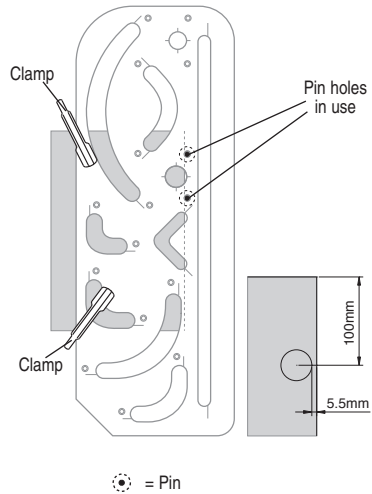

Ensure jig overhang is supported.

ENVIRONMENTAL PROTECTION

Recycle raw materials instead of disposing as waste.

Packaging should be sorted for environmental-friendly recycling.

The product and its accessories at the end of their life should be sorted for environmental friendly recycling.

GUARANTEE

The jig carries a manufacturers guarantee in accordance with the conditions on the enclosed guarantee card.

AR/JIG - SPARE PARTS DIAGRAM

v1.0 03/2014

Please use only Trend original spare parts.

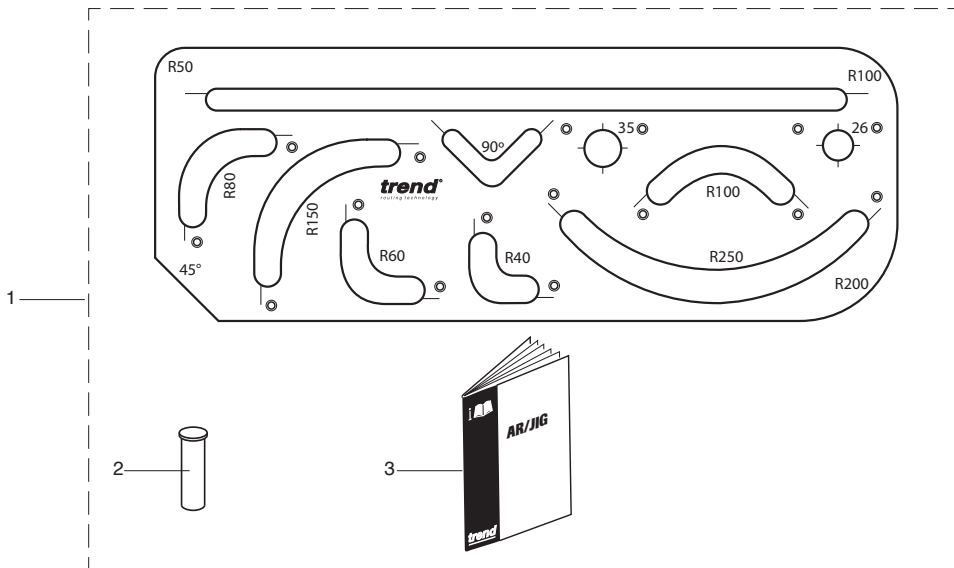

AR/JIG - SPARE PARTS LIST			v1.0 03/2014
No.	Qty.	Desc.	Ref.
1	1	AR/JIG	AR/JIG
2	1	Pin 10mm Plastic (Pack of 4)	KWJ/PIN/4
3	1	Manual	MANU/AR

MANU/AR v1.3



RECYCLABLE

Trend Machinery & Cutting Tools Ltd.

Odhams Trading Estate St Albans Road
Watford WD24 7TR England

Tel: 0044(0)1923 249911
technical@trendm.co.uk

www.trend-uk.com