



Keyhole Cutter 35/0, 35/01 & C120



INST/35/0 v6.2

trend[®]
routing technology

Please read carefully before use

KEYHOLE CUTTER REF. 35/0, 35/0, 35/01 & C120

Thank you for purchasing this Trend router cutter, which should give lasting performance if used in accordance with these instructions.

The following symbols are used throughout these instructions.



Denotes risk of personal injury, loss of life or damage to the tool in case of non-observance of the instructions.



Refer to the instruction manual of your power tool.

This cutter must not be put into service until it has been established that the power tool to be connected to this unit is in compliance with 2006/42/EC (identified by the CE marking on the power tool).

INTENDED USE

This cutter can be used both in a portable router or in a fixed position, either mounted overhead or inverted in a table to rout wood and wood based materials.

Keyhole cutters are used to keyhole recess articles hanging flush to the wall. Depending on the cutter used the keyhole is suitable for screw sizes of No.8, No.10 or No.12 with either round head or countersunk head.

SAFETY

Please read and understand the safety points at the end of this instruction as well as the power tool instructions before use.

PLEASE KEEP THESE INSTRUCTIONS IN A SAFE PLACE.

The attention of UK users is drawn to The Provision and Use of Work Equipment Regulations 1998, and any subsequent amendments.

Users should also read the HSE/HSC Safe Use of Woodworking Machinery Approved Code of Practice and Guidance Document and any amendments.

Users must be competent in using woodworking equipment before using our products.

Ensure working position is comfortable and component is clamped securely. Please keep children and visitors away from tools and work area. All tools have a residual risk, so must therefore be handled with caution.

Attention should be made to the HSE's Safe Use of Vertical Spindle Moulding machines Information Sheet No. 18 and any revisions.

ITEMS REQUIRED

- Plunge router with suitable collet fitted.
- Guide bush 30mm diameter.
- Router table (preferable).
- Hand tools.
- Jig making materials.

Product Ref.	Screw Size	Maximum Depth of Cut
35/0	No.8, No.10	9mm
C120	No.8, No.10	9mm
35/01	No.10, No.12	9mm

OPERATION



Carefully remove the protective wax from the cutter and dispose. Insert the cutter shank into the collet all the way to the marked line indicated on the shank. This ensures at least 3/4 of the shank length is held in the collet.

The cutters should be used with a user-made jig to ensure an accurate cut.

The jig is used in conjunction with a guide bush fitted to the underside of the router base. The recommended diameter of guide bush is 30mm Ref. GB30.

The jig is slotted to allow forward movement of the guide bush/cutter of minimum 10mm. The cutter is plunged into the workpiece to a maximum of 9mm deep to create the entry hole and moved forward to create the shoulder. The cutter is then returned to the original entry position and retracted out of the entry hole (see stages overleaf).



These cutters are not for continuous grooving operations.



Recommended speed is 24,000 rpm.

ENVIRONMENTAL PROTECTION

Recycle raw materials instead of disposing as waste.

Packaging should be sorted for environmental-friendly recycling.

The product and its accessories at the end of its life should be sorted for environmental-friendly recycling.

GUARANTEE

All Trend products are guaranteed against any defects in either workmanship or material, except products that have been damaged due to improper use or maintenance.

© Trend Machinery & Cutting Tools Ltd. 2014 E&OE
© All trademarks acknowledged

Trend Machinery & Cutting Tools Ltd.

Odhams Trading Estate St Albans Road
Watford WD24 7TR England
Tel: 0044(0)1923 249911
technical@trendm.co.uk
www.trend-uk.com



PTO

5 027654 318898 >



RECYCLABLE

Making the Keyhole Recess Jig ⚠

The jig should be made from 12mm Medium Density Fibreboard (MDF) with dimensions of approximately 300mm long x 180mm wide.

A slot 30mm diameter by 40mm long is machined into the MDF. The diameter must be large enough to allow the 30mm OD guide bush to move freely.

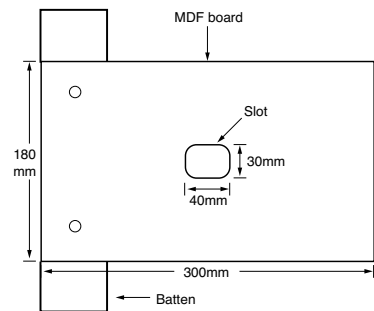

30mm guide bush
Ref. GB/30

At one end of the MDF board a batten should be fitted. The distance from the inside of the batten to the centre of the slot should be to suit the application required.

Routing Stage 1 ⚠

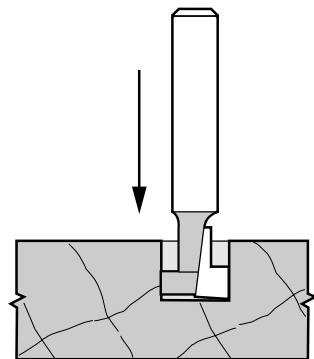

Side view

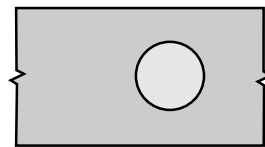

Plan view

Routing Stage 2 ⚠

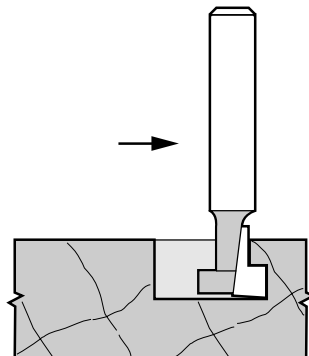

Side view

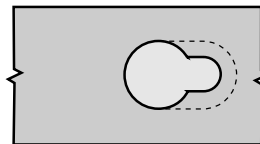

Plan view

Routing Stage 3 ⚠

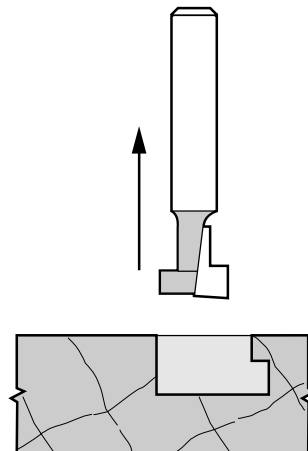

Side view

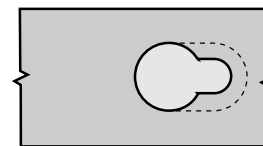

Plan view

SPARE PARTS

Please use only Trend original spare parts and accessories.

MAINTENANCE ⚠

Continual satisfactory operation depends upon proper tool care and regular cleaning.

Cleaning

- Remove resin build-up regularly.
- Apply a rust protector to shanks.

Lubrication

- Use a PTFE dry lubricant spray on tool.
- Apply a rust protector to shanks.

Storage

Always return cutter to its packaging after use.

Safety Points

1. Disconnect power tool and attachment from power supply when not in use, before servicing, when making adjustments and when changing accessories such as cutters. Ensure switch is in "off" position and cutter has stopped rotating.
 2. Read and understand instructions supplied with power tool, attachment and cutter.
 3. Current Personal Protective Equipment (PPE) for eye, ear and respiratory protection must be worn. Keep hands, hair and clothes clear of the cutter.
 4. Before each use check cutter is sharp and free from damage. Do not use if cutter is dull, broken or cracked or if any damage is noticeable or suspected.
 5. The maximum speed (n_{max}) marked on tool or in instructions or on packaging shall not be exceeded. Where stated, the speed range should be adhered to.
 6. Insert the shank into the router collet at least all the way to the marked line indicated on the shank. This ensures at least 3/4 of shank length is held in collet. Ensure clamping surfaces are clean.
 7. Check all fixing and fastening nuts, bolts and screws on power tool, attachment and cutting tools are correctly assembled, tight and to correct torque setting before use.
 8. Ensure all visors, guards and dust extraction is fitted.
 9. The direction of routing must always be opposite to the cutter's direction of rotation.
 10. Do not switch power tool on with the cutter touching the workpiece.
 11. Trial cuts should be made in waste material before starting any project.
 12. Repair of tools is only allowed according to tool manufacturers instructions.
 13. Do not take deep cuts in one pass, take shallow passes to reduce the side load applied to the cutter.
- Please see www.trend-uk.com/safety for more safety advice.



Our policy of continuous improvements mean that specifications may change without notice. Trend Machinery & Cutting Tools Ltd. cannot be held liable for any material rendered unusable, or for any form of consequential loss.