



Intumescent Strip Cutter 348

Please read carefully before use



INTUMESCENT STRIP RECESSING CUTTER REF. 348

Thank you for purchasing this Trend router cutter, which should give lasting performance if used in accordance with these instructions.

The following symbols are used throughout these instructions.



Denotes risk of personal injury, loss of life or damage to the tool in case of non-observance of the instructions.



Refer to the instruction manual of your power tool.

This cutter must not be put into service until it has been established that the power tool to be connected to this unit is in compliance with 98/37/EC (identified by the CE marking on the power tool).

INTENDED USE

This cutter is intended to be used in a router to produce the correct width and depth of cut for standard 15mm x 4mm intumescent strip in a fire door or frame.

SAFETY

Please read and understand the safety points at the end of this instruction as well as the power tool instructions before use.

PLEASE KEEP THESE INSTRUCTIONS IN A SAFE PLACE.

The attention of UK users is drawn to The Provision and Use of Work Equipment Regulations 1998, and any subsequent amendments.

Users should also read the HSE/HSC Safe Use of Woodworking Machinery Approved Code of Practice and Guidance Document and any amendments.

Users must be competent in using woodworking equipment before using our products.

ITEMS REQUIRED

- Router with suitable collet fitted.
- 14mm A/F spanner.
- Intumescent strip.
- Hand tools.
- Trestle x2.
- Clamps x2.

ITEMS ENCLOSED & DESCRIPTION OF PARTS

- A. Arbor **x1**
- B. Bearing 32mm diameter **x1**
- C. Washer 2mm thick **x1**
- D. Slotter 15mm Kerf x 40mm dia. **x1**
- E. Instructions **x1**

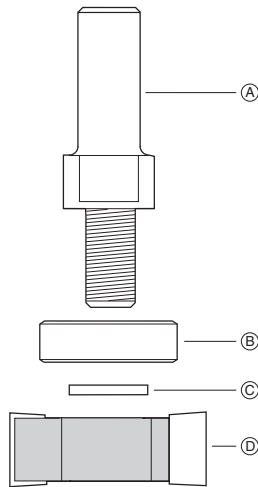

Before using cutter, please ensure it is correctly assembled and locking nut/groover is fully tightened to correct torque setting.

OPERATION



Carefully remove the protective wax from the cutter and dispose.

Insert the cutter shank into the collet at least all the way to the marked line indicated on the shank. This ensures at least 3/4 of the shank length is held in the collet.

Set the cutter height and rout the groove in the edge of the door or frame. A wider strip can be accommodated by changing the cutter height.



Recommended speed is 18,000rpm.

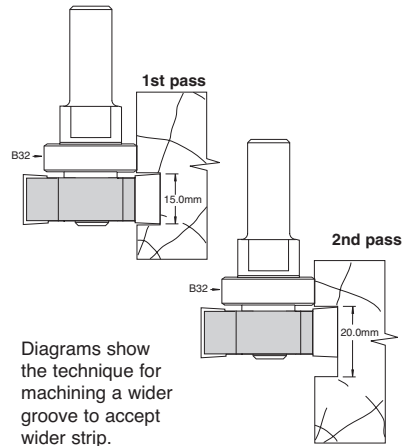

Diagrams show the technique for machining a wider groove to accept wider strip.

ENVIRONMENTAL PROTECTION

Recycle raw materials instead of disposing as waste.

Packaging should be sorted for environmental-friendly recycling. The product and its accessories at the end of its life should be sorted for environmental-friendly recycling.

GUARANTEE

All Trend products are guaranteed against any defects in either workmanship or material, except products that have been damaged due to improper use or maintenance.

© Trend Machinery & Cutting Tools Ltd. 2009 E&OE
© All trademarks acknowledged

Trend Machinery & Cutting Tools Ltd.
Odhams Trading Estate St. Albans Road
Watford WD24 7TR England
Tel: 0044(0)1923 249911
technical@trendm.co.uk
www.trend-uk.com



RECYCLABLE



Types of Intumescent Strip

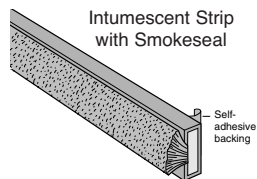
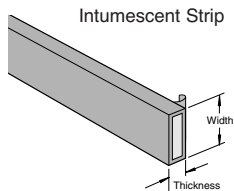

Types of Applications

For either frame or door applications, with standard or smoke seal Intumescent Strip.

Door Applications

Half hour rating One hour rating

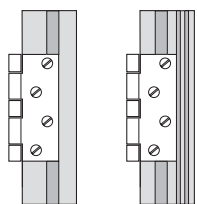

Frame Applications

Half hour rating One hour rating

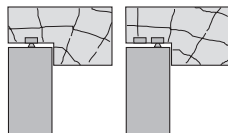

ACCESSORIES

Please use only Trend original accessories.

Alternative Bearings

Adding alternative bearings will give a different depth of cut allowing you to use the cutter for other sizes of intumescent strip and other applications that may arise. This diagram shows the different depths that can be achieved by using alternate bearings.

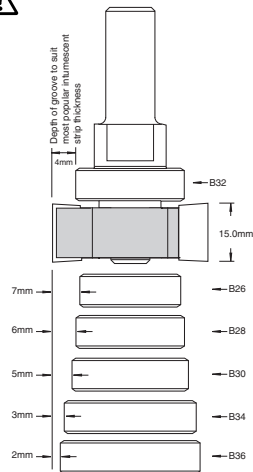

| Bearing Ømm | Strip thickness | Ref. (1 off) |
|-------------|-----------------|--------------|
| 26 | 7 | B26 |
| 28 | 6 | B28 |
| 30 | 5 | B30 |
| 34 | 3 | B34 |
| 36 | 2 | B36 |

SPARES PARTS

Please use only Trend original spare parts.

| Item | Qty | Desc. | Ref. (1 off) |
|------|-----|-------------------|--------------|
| A | 1 | Arbor 1/2" shank | 33/21X1/2 |
| B | 1 | Bearing 32mm dia. | B32 |
| D | 1 | Slotter 15mm kerf | 34/16TC |
| | 1 | Spacer set | SPACER/12 |
| E | 1 | Instructions | INST/348 |

MAINTENANCE

Continual satisfactory operation depends upon proper tool care and regular cleaning.

Cleaning

- Ensure clamping surfaces are cleaned to remove dirt, grease, oil and water.
- Remove resin build-up regularly.

- Apply a rust protector to shanks. Do not use rust protector on ball bearing guides.

Lubrication

- Use a PTFE dry lubricant spray on tool to increase cutting edge life.

Storage

- Always return cutter to its packaging after use.

Safety Points

1. Disconnect power tool and attachment from power supply when not in use, before servicing, when making adjustments and when changing accessories such as cutters. Ensure switch is in "off" position and cutter has stopped rotating.
2. Read and understand instructions supplied with power tool, attachment and cutter.
3. Current Personal Protective Equipment (PPE) for eye, ear and respiratory protection must be worn. Keep hands, hair and clothes clear of the cutter.
4. Before each use check cutter is sharp and free from damage. Do not use if cutter is dull, broken or cracked or if any damage is noticeable or suspected.
5. The maximum speed (nmax) marked on tool or in instructions or on packaging shall not be exceeded. Where stated, the speed range should be adhered to.
6. Insert the shank into the router collet at least all the way to the marked line indicated on the shank. This ensures at least 3/4 of shank length is held in collet. Ensure clamping surfaces are clean.
7. Check all fixing and fastening nuts, bolts and screws on power tool, attachment and cutting tools are correctly assembled, tight and to correct torque setting before use.
8. Ensure all visors, guards and dust extraction is fitted.
9. The direction of routing must always be opposite to the cutter's direction of rotation.
10. Do not switch power tool on with the cutter touching the workpiece.
11. Trial cuts should be made in waste material before starting any project.
12. Repair of tools is only allowed according to tool manufacturers instructions.
13. Do not take deep cuts in one pass, take shallow passes to reduce the side load applied to the cutter.

Please see www.trend-uk.com/safety for more safety advice.



Our policy of continuous improvements mean that specifications may change without notice. Trend Machinery & Cutting Tools Ltd. cannot be held liable for any material rendered unusable, or for any form of consequential loss.