

trendTM
tool technology

WOODWORKING INNOVATIONS

SPRING 2020

Products and solutions for woodworkers, contractors and cabinet makers.



SHARPENING

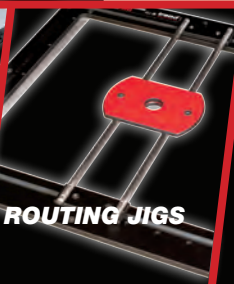

ROUTING JIGS



SAFETY

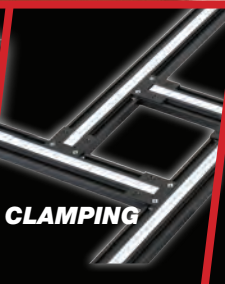

CLAMPING



FLASHLIGHTS



ROUTER BITS



MEASURING

WELCOME BACK

The Trend Stealth half mask respirator is the first in a family of innovative next generation filtration products that we will be introducing to the North American marketplace within the next year. Please see page 17 for details on this remarkable new product.

The Essential Diamond Sharpening Kit is the Trend sharpening philosophy in a carrying case - this is the ideal Mothers Day, Fathers Day, Holiday or Gift to Me gift!

A new line of flashlights and industrial grade storage products are also part of the Trend 2019 Autumn new product introductions.

Clearly, 2020 will be the year of the new product for Trend. Please keep visiting our soon to be upgraded website, subscribe to the Trend YouTube channel and like our Facebook page for updates.

We appreciate your business!



Jamie LaMuraglia
Vice-President Sales & Marketing

trend-usa.com



/TrendRoutingTechnology



/TrendMachinery



@TrendRouting

NEW PRODUCTS for

AIRSTEALTH N100 HALF MASK

New generation mask, with low profile ergonomic design.

Refs **U*STEALTH/SM**
U*STEALTH/ML Page 17



Maximum Filtration



Maximum Breathability



8+ HOURS Maximum Comfort



ESSENTIAL DIAMOND SHARPENING KIT

Ref **U*DWS/KIT/H**

Page 8



To maintain, sharpen and polish tools.

MIRROR PASTE KIT

Ref **U*DWS/MP/KIT**

Page 9



LED FLASHLIGHTS & HEADLAMPS

A high quality range suitable for all trades. Refs **U*TCH/** Page 20-21



2019

ROUTER POD

Ref U*R/POD/A Page 26



Simple routing accessory designed to keep your router in a safe upright position when not in use.



JOINTING BISCUITS

Ref U*BSC/ Page 25



DIGITAL LEVEL BOX

Ref U*DLB Page 27



DRAINING GROOVE PRO JIG FRAME

Ref U*DG/PRO Page 11



Allows different drainer grooves to be routed in solid timber and solid surface worktops.



SCRIBE-MASTER COPE PRO JIG

Ref U*SM/PRO Page 10



Base board cope jig for use with a router.



CONTENTS

DIAMOND SHARPENING

TECHNICAL INFORMATION	2
DOUBLE-SIDED SLIP STONES	3
BENCH STONES	4-5
DIAMOND FILES	6-7
DIAMOND KITS	8
SHARPENING ACCESSORIES	9

ROUTING JIGS

STAIRCASE HOUSING JIG	10
SCRIBE-MASTER COPE PRO JIG	10
DRAINING GROOVE PRO FRAME	11
DOOR HINGE JIG	12-13
DOOR HANGING ACCESSORIES	14
LOCK JIG	15

SAFETY

AIRSHIELD PRO	16
AIR STEALTH HALF MASK	17

VARIJIG SYSTEM

VARIJIG CLAMP GUIDES	18
VARIJIG FRAME SYSTEM	19

LED FLASHLIGHTS & HEADLAMPS

20-21

ROUTER BITS & ACCESSORIES

ROUTER BITS	22-25
BEARINGS & COLLET EXTENSIONS	25
WOODEN BISCUITS	25
SHELF SUPPORT TEMPLATE	26
ROUTER POD	26
TOOL CLEANER	26
UNIVERSAL COUNTERSINK	27

MEASURING & MARKING

DIGITAL LEVEL BOX	27
MULTISCRIBE	27
DEPTH GAUGES	28
DIGITAL ANGLE RULES	29
DIGITAL ANGLE FINDER	29

DIAMOND SHARPENING SOLUTIONS



A precision range of quality diamond whetstones for all your sharpening needs.

- Double-sided stones.
- Suitable for all Carbide and HSS hand tools.
- Woodworking, turning, carving, gardening and domestic.
- 'Excellence in Engineering' award.
- Unprecedented five year guarantee.



TIP

Use little pressure, let the diamond do the work, use the weight of the tool only on the surface of the stones.

TECHNICAL INFORMATION

CONSTRUCTION

Monocrystalline micronized diamonds are electroplated onto a precision pre-ground substrate. Electroplating produces very durable products, hence an unprecedented 5 year warranty. The following micron sizes of diamond have been chosen as the optimum for performance of the great variety of hand tools that can be sharpened using this range. The diamond is set into nickel, 2/3 buried and 1/3 exposed (locked in like an iceberg), thus the 1000 grit surface, 15 micron has a sharpening medium of 5 micron.

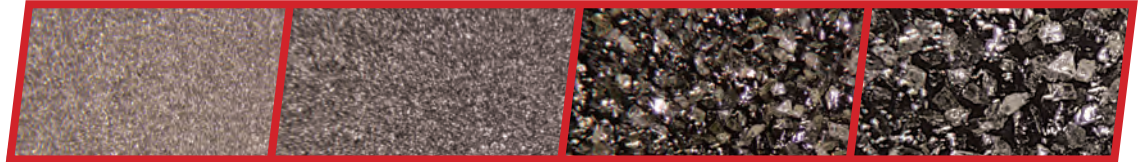

EXTRA FINE 15 Micron/1000 Grit

1000 grit is perfect for producing razor/polished edges with a very fast speed of cut. Ideal for carvers, cabinet makers, hunting knives, all fine woodworking.

FINE 25 Micron/600 Grit

600 grit is the most suitable grade for general fine sharpening. Ideal for Carbide router bits, turning tool inserts and circular sawblades.

COARSE 50 Micron/300 Grit

300 grit has been chosen to optimise the speed of cut for large stock removal. It is an ideal grit size for flattening the backs of chisels and plane blades. Also the popular choice for general joinery/site work and several applications in the woodturning industry. Ideal for all HSS.

EXTRA COARSE 70 Micron/180 Grit

180 grit is made for rapid stock removal. Ideal for flattening waterstones, planer blades and chisels, re-shouldering knives, and taking nicks out of edges.



MAINTENANCE

Trend Lapping Fluid should be used in conjunction with the Cleaning Block which will benefit the product and greatly lengthen its life span. We recommend that you use lapping fluid as a lubricant and NOT water or water based products on all diamond products to prevent rusting and clogging. It prevents the build-up of residue which occurs when sharpening.

Lapping fluid was designed in the engineering industry over 30 years ago solely for use on diamond abrasives.

The Trend cleaning block is similar to a drawing office eraser, the consistency is soft and putty like. If the surface of the stone becomes discolored after constant use, the cleaning block restores it.



DOUBLE-SIDED SLIP STONES

A comprehensive range of slip stones for hand tooling:

- General Joinery
- Cabinet Making
- Turning
- Carving
- Pruners
- Loppers
- Shears
- Axes
- Budding Knives
- Scissors
- Kitchen Knives
- Serrated
- Straight Blades
- Hunting Knives
- Axes

3" POCKET STONE

A double-sided fine/coarse 600/300 grit pocket stone. Ideal for small tools. Supplied in a wallet.

Product Reference

U*DWS/P3/FC

Size: 3" x 1" x 1/16", 600/300 Grit



3" CREDIT CARD STONES

A double-sided coarse/extra coarse 300/180 grit credit card size stone. Ideal for woodturners, on-site chisel flattening and hunters in the field.

Product Reference

U*DWS/CC/CX

Size: 3-1/4" x 2" x 1/16", 300/180 Grit



A double-sided fine/coarse 600/300 grit stone, with grit sizes for easy identification. Ideal for Carbide & HSS shaped router bits, Carbide inserts, woodturning tools and general woodworking. Supplied in a wallet.

Product Reference

U*DWS/CC/FC

Size: 3-1/4" x 2" x 1/16", 600/300 Grit



5 X 1" POCKET STONES

A double-sided extra fine/extra coarse pocket stone. 1000/180 grit is ideal for hunters, farmers and maintenance crews. Supplied in a wallet.

Product Reference

U*DWS/PP5/FX

Size: 5" x 1" x 1/16"
1000/180 Grit

A double-sided fine/coarse thin pocket stone for sawblades, small tools and knives. 600/300 grit is excellent for general purpose sharpening.

Product Reference

U*DWS/PP5/FC

Size: 5" x 1" x 1/16", 600/300 Grit



3" CARVERS STONE

Almost twice as thick as standard credit card stones. Double-sided extra fine/fine 1000/600 grit stone has grit sizes for easy identification. Ideal for carving tools, Carbide and very fine edge sharpening.

Product Reference

U*DWS/CS/FF

Size: 3-1/4" x 2" x 1/16"
1000/600 Grit





PRECISION DIAMOND BENCH STONES

DOUBLE-SIDED BENCH STONES

**Monocrystalline diamonds
electroplated onto a precision
ground substrate.**

- Fine grit is suitable for achieving a razor, shaving edge in seconds. Ideal for cabinet making and fine woodworking.
- Coarse grit re-shapes and re-hones damaged edges, ideal for site work, general joinery and flattening chisels and plane blades.
- Precision flatness enables the sharpening of Carbide and HSS inserts, spindle knives and clipper blades.
- Supplied with non-slip mat and cleaning block. U*DWS/B7/FC supplied in fabric tool holder.
- Use with Trend lapping fluid.

EXTRA FINE SIDE

1000 Grit 15 Micron

COARSE SIDE

300 Grit 50 Micron

Product Reference

U*DWS/W6/FC

Size: 6" x 2" x 5/16"



Product Reference

U*DWS/B7/FC

Size: 7" x 2.5" x 3/8"



BENCH STONE HOLDER

- Adjustable to clamp bench stones securely.

Product Reference

U*DWS/BH/B7

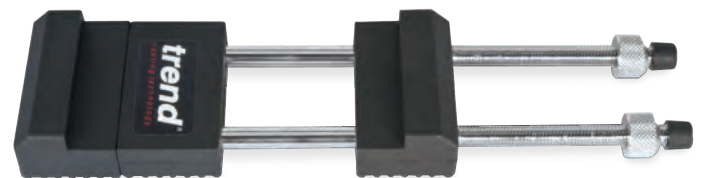

SPECIFICATION

Min. stone length _____ 5-1/2"
Max. stone length. _____ 8-1/4"

CLASSIC PROFESSIONAL BENCH STONES

DOUBLE-SIDED WORKSHOP STONE

**Unique combination of surfaces
for optimum performance.**

- Precision flatness, with pre-ground substrate.
- Prevents 'snagging' in holes when sharpening small or pointed tooling.
- Clearance channels on the coarse surface disperses the residue faster when heavy stock removal is required thus increasing the speed of cut.
- Continuous diamond fine surface ideal for fine honing of knives, plane blades and chisels.
- Supplied in fabric tool holder with non-slip mat and cleaning block.

EXTRA FINE SIDE

1000 Grit 15 Micron

COARSE SIDE

300 Grit 50 Micron

Product Reference

U*DWS/CP8/FC

Size: 8" x 3" x 5/16"



DOUBLE-SIDED FLATTENING STONE

**An updated version of this
popular classic bench stone.
For flattening oil or water stones.**

- 600 Grit fine 25 micron continual diamond surface for removal of scratches left after flattening tools such as chisels and plane blades before progressing to fine honing and polishing.
- 180 Grit extra coarse 70 micron surface with clearance channels for rapid stock removal in flattening and re-shouldering operations.
- Suitable for quick fine edge for contractors and on-site honing. Ideal for honing Carbide inserts.

FINE SIDE

600 Grit 25 Micron

EXTRA COARSE SIDE

180 Grit 70 Micron

Product Reference

U*DWS/CP8/FX

Size: 8" x 3" x 5/16"



SHARPENING





DIAMOND FILES

Sharpening solutions for all tooling used by professionals and hobbyists alike:

- Shaped Tools
- Carbide Inserts
- Pruners
- Gouges
- Scissors
- Serrated Blades
- Forstner Bits
- Skews
- Loppers
- Router Bits
- Scrapers
- Knives
- Sawblades
- Hoof Knives
- Axes

6" TAPERED FILE

Flat top and convex back tapered file.

- Fine 600 grit (25 micron) monocrystalline diamond.
- For all hand tools.
- Ideal for garden and domestic applications.

Product Reference

U*DWS/TF6/F

Size: 10-5/8" overall length with 6" diamond length.



3" FINE TAPERED FILE

A versatile half round/flat tapered file for woodworking, gardening and domestic tooling.

- Precision quality taper file.
- Fine 400 grit (35 micron) monocrystalline diamond.
- Split plastic contoured hand-grip which is pinned each side of blade.
- Designed for woodturning and carving tools. Sharpens Carbide Tipped tooling in seconds.

Product Reference

U*DWS/TF3/F

Size: 6" overall length with 3" diamond length thickness 3/32" to 1/16".

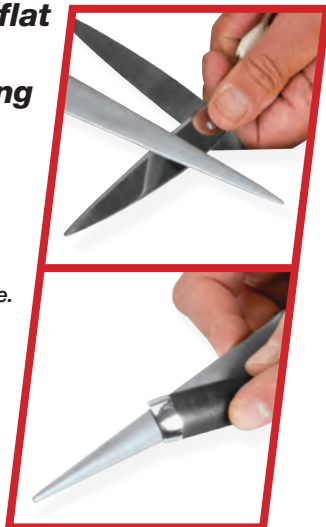

3" MINI FINE TAPERED FILE

Precision quality taper file.

- Fine 600 grit (25 micron) monocrystalline diamond.
- Split plastic contoured hand-grip which is pinned either side of blade.
- Suitable for sharpening forstner bits, rotary carving, woodturning and carving tools. Unique size allows access to difficult sharpening problems.

Product Reference

U*DWS/TF3M/F

Size: 6" overall length with 3" diamond length, thickness 1/8" to 1/16".



MACHINIST FILE

Double-sided 2-3/8 inch fine/coarse machinist file.

- Fine 600 grit (25 micron) and coarse 300 grit (50 micron) monocrystalline diamond.
- Diamond is electroplated onto a steel substrate which is molded onto the hardened plastic handle. The result is an extremely durable, versatile and strong product.
- Suitable for woodturning gouge internal and external bevel edges, skewers, carving tools, model engineering, router bits, small chisels, knives, serrated edges, metals and plastics, pruners, shears and all shaped tooling.

Product Reference

U*DWS/MF/FC

Size: 7" overall length with 2-3/8" diamond length, width 7/8", thickness 3/8" to 1/4".

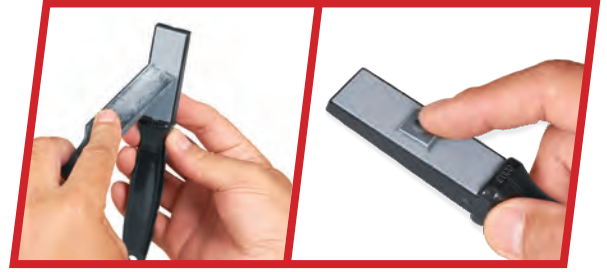

RETRACTABLE PENFILE

- Suitable for use on turning and carving tools, shaped tools and profiles.
- Also for woodworking, gardening and domestic use.
- Unscrew from body which then becomes a handle.

Product Reference

U*DWS/PFR/F

Size: 5-5/8" x 7/16"

File length: 3-5/8" x 15/64" diameter



Retracted



Open

DIAMOND STEELS

Sharpens serrated, straight and scalloped blades in seconds.

- Use with little pressure, slowly and softly.
- Alternate strokes achieve a razor edge.

Product References

U*DWS/DS10/F length 10"

U*DWS/DS12/F length 12"



PRECISION NEEDLE FILES

Four precision quality electroplated monocrystalline diamond files.

- Fine 600 grit.
- Diamond coverage 3" (overall length 6-5/16").
- Supplied to the Aerospace industry.
- Ideal for wood, metals, plastics, glass and ceramics.

Product Reference

U*DWS/NFPK/F

- ▭ Flat
- ◐ Half round taper flat
- △ Triangular taper
- Round taper

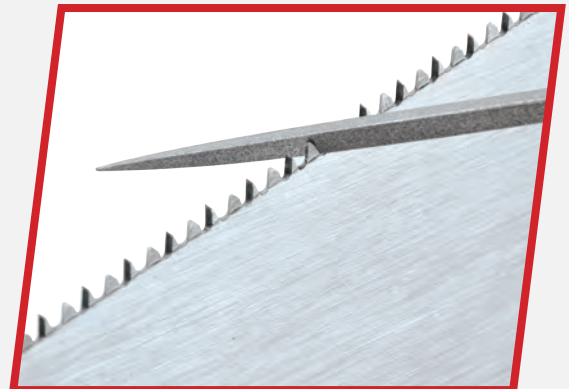

DIAMOND KITS

ULTIMATE BENCH STONE SHARPENING KIT **NEW**

The ultimate sharpening and maintenance kit for kitchen, hunting and pocket knives. It includes two 8" x 3" double-sided bench stones which employ four diamond grits (180, 300, 600, 1000 grits). Supplied in an aluminum carry case.

INCLUDES

- U*DWS/CP8/FC 8" x 3" extra fine/coarse double-sided bench stone
- U*DWS/CP8/FX 8" x 3" fine/extra coarse double-sided bench stone
- U*DWS/LF/100 Lapping fluid 3.4 fl.oz
- U*DWS/HP/US Honing compound bar
- U*DWS/NM/W8 Non-slip mat
- U*DWS/HP/LS Leather strop
- U*DWS/CB/A Cleaning block
- U*BOOK/DWS Booklet



Product Reference
U*DWS/KIT/E



HONING & POLISHING KIT

Ideal for chisels, plane blades and all hand tools.

Product Reference
U*DWS/KIT/B

INCLUDES

- U*DWS/CP8/FC 8" x 3" bench stone
- U*DWS/HG/SET Honing guide set
- U*DWS/LF/100 Lapping fluid
- U*DWS/HP/LS Leather strop
- U*DWS/HP/US Honing compound bar
- U*DWS/NM/W8 Non-slip mat
- U*DWS/CB/A Cleaning block
- U*BOOK/DWS Booklet
- U*DVD/DWS/SME DVD



COMPLETE SHARPENING KIT

For forstner bits, turning tools, router bits, chisels, Carbide & HSS inserts.

Product Reference
U*DWS/KIT/C

INCLUDES

- U*DWS/CC/FC Credit card stone with non-slip mat.
- U*DWS/TF3M/F 3" Mini taper file
- U*DWS/LF/100 Lapping fluid
- U*DWS/CB/A Cleaning block
- U*BOOK/DWS Booklet
- U*DVD/DWS/SME DVD



CREDIT CARD SHARPENER KIT

Includes two heavy duty stones which offer 180, 300, 600 & 1000 grit.

Product Reference
U*DWS/KIT/D

INCLUDES

- U*DWS/CC/CX Credit card stone, coarse 300 grit and extra coarse 180 grit with non-slip mat.
- U*DWS/CS/FF Credit card stone, extra fine 1000 grit and fine 600 grit.
- U*DWS/LF/100 Lapping fluid
- U*DWS/CB/A Cleaning block
- U*BOOK/DWS Booklet
- U*DVD/DWS/SME DVD



ESSENTIAL SHARPENING KIT **NEW**

Everything needed to flatten, hone and polish plane irons, knives and chisels. Supplied in a heavy duty aluminum carrying case.

Product Reference
U*DWS/KIT/H

INCLUDES

- U*DWS/CP8/FC 8" x 3" extra fine/coarse double-sided bench stone.
- U*DWS/HP/LS Leather strop
- U*DWS/LF/100 Lapping fluid
- U*DWS/MP/40 Mirror paste
- U*DWS/CB/A Cleaning block



SHARPENING ACCESSORIES

TREND LAPPING FLUID

Use with quality diamond abrasive products.

- A petroleum based synthetic lubricant to be used with diamond compounds.
- An advanced lubricant, with penetrating qualities and oil/water solubility, not only increases the cutting action, but assures superior lubrication of every diamond particle throughout the honing process and greatly reduces the risk of rusting.
- Ideal for cleaning and reduces the risk of clogging in CBN wheels.



Product References

U*DWS/LF/100 3.4 fl.oz

U*DWS/LF/250 8.5 fl.oz

U*DWS/LF/500 17 fl.oz

Cleaning Block for all stones

U*DWS/CB/A



HONING GUIDE

Set the perfect angle for chisels and plane blades.

- Easy to set, complete with the unique angle setting plate which is preset for 25°, 30°, 35° and 40° angles.
- Clamps from the sides to keep tool square.
- Clamps from 3/8" to 1-1/4" bevel edge chisels and up to 2-3/8" wide plane irons.
- Maximum tool thickness 0.275".

Product Reference

U*DWS/HG/SET



MIRROR PASTE **NEW**

Micro fine abrasive paste for a mirror finish on blades.

- Puts a polished edge on carving tools, chisels, plane blades and knives.
- Offers a mirror finish on cutting edges for clean cuts.



Product Reference
U*DWS/MP/40

1.2 fl.oz
2-3 micron,
8000 - 10000 grit



MIRROR PASTE **NEW** & STROP KIT

Achieve a mirror finish on all your workshop tools.

- Apply mirror paste to strop, rub to absorb and then stroke edge until polished finish.



Product Reference
U*DWS/MP/KIT

INCLUDES

U*DWS/MP/40
Mirror paste

U*DWS/HP/LS
Leather strop



HONING COMPOUND BAR & STROP KIT

Achieve a polished finish on chisels and plane irons.

- Used to give a highly polished finish to a sharpened cutting edge.

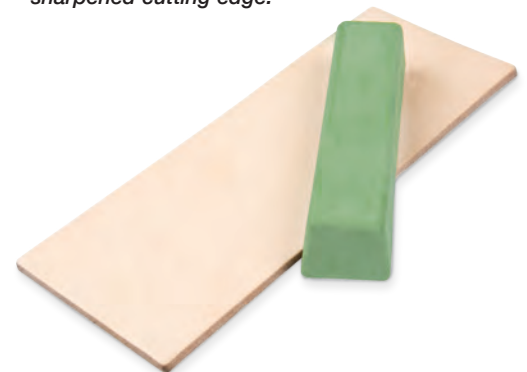

Product Reference
U*DWS/HP/KIT

INCLUDES

U*DWS/HP/US
Honing compound bar

U*DWS/HP/LS
Leather strop



STAIRCASE HOUSING JIG

CLOSED RISER

This template jig is a well proven means of routing out stair housings quickly.

- For use with heavy duty routers with 1/2" shank capacity and over 2HP.
- Constructed from solid laminate.
- Reversible and adjustable angle fence for the exact matching of stair strings.
- Integral, reversible and adjustable front clamp.
- Adjustable nosing and uses dovetail bits to give a neat joint.

Product Reference
U*STAIR/A

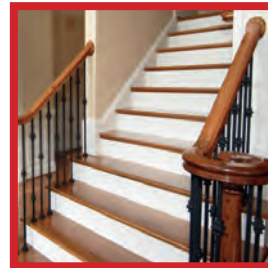
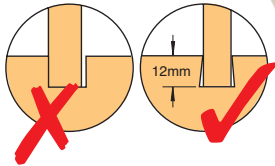

INCLUDES

- 1 x Sub-base
- 1 x Adjustable reversible clamp
- 1 x Reversible clamp bar
- 1 x Nosepiece
- 1 x Line-up pin & bush
- 2 x Spanners

OPTIONAL ACCESSORIES

Recommended Professional Dovetail Bits
Product Ref. Tread Thickness Bit Dia.

U*32/10X1/2TC	7/8" (22mm)	14mm
U*32/11X1/2TC	1" (25.4mm)	16mm
U*32/12X1/2TC	1-1/8" (28.5mm)	19mm
U*32/13X1/2TC	1-1/4" (32mm)	22mm

Recommended CraftPro Dovetail Bits
Product Ref. Tread Thickness Bit Dia.

U*C240X1/2TC	7/8" (22mm)	13.5mm
U*C241X1/2TC	1" (25.4mm)	16mm
U*C242X1/2TC	1-1/8" (28.5mm)	19mm
U*C243X1/2TC	1-1/4" (32mm)	22mm

* 7/8" tread will have a slight gap under nosing.

NEW

Carry Case
U*CASE/DG



REPLACEMENT PARTS

- Complete Sub-base
U*WP-SJA/16
- Sub-base (plate only)
U*WP-SJA/12
- Nosepiece
U*WP-SJA/15

SCRIBE-MASTER COPE PRO JIG

WORKS WITH ANY PROFILE

NEW



trend-uk.com/video

Rout base boards and rails easily with this cope jig.

- Cuts precise left and right hand copes in 15 seconds.
- Fully variable, up to ten times faster than manual scribes.
- Scribes profile into kitchen plinths.
- Scribes warped boards and suitable for walls that are not plumb.
- Made from high pressure laminate for stability.
- Requires a medium/heavy duty plunge router with 1-3/16" guide bush fitted.

Product Reference
U*SM/PRO



Copes base boards



Copes dado rails

SPECIFICATION

Size _____ 21-21/32" x 12-9/32" x 5"
Board height _____ 7-43/64"
Max. thickness board _____ 1-17/64"
Min. length board _____ 11-13/16"
Weight _____ 13 lbs

INCLUDES

- 1 x 5/32" spiral 1/4" shank HSSE spiral router bit.
- 1 x Comb aligning tool
- 1 x Hold down clamp

OPTIONAL ACCESSORIES

- Quick mount kit for mitre saw leg stand.
U*SM/MKP
- Tenon slide plate for through housings, half laps and tongue & groove lining joints.
U*SM/TSP
- HSSE 8mm shank bit two flute down-cut for hardwood.
U*SMC/03X8MMHSS

- Carry bag
U*SM/BP
- Universal sub-base
U*UNIBASE
- 1-3/16" (30mm) guide bush
U*GB30



DRAINING GROOVE PRO JIG FRAME

NEW



trend-uk.com/video

UK Patent No. GB1718517.4

ROUTING JIGS & ACCESSORIES

An X and Y-axis routing jig that allows different drainer grooves to be routed in solid timber and solid surface worktops when used with inner templates.

- Outer frame has 0.5° degree fall.
- Router carriage has hole to accept 1-3/16" guide bush and can be locked to allow parallel groove routing for standard drainer grooves.
- Made from 15/32" thick hard-wearing machined high pressure laminate.
- Use with a router with 1-3/16" guide bush fitted and suitable cutter.
- Five accessory inner templates available to give various groove effects.
- Router carriage can also be used for surfacing applications.
- Outer frame has index holes at 25mm centres to restrict length of slots and includes two index pins.





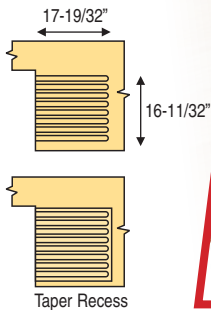



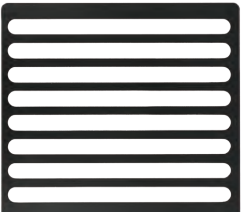

Product Reference
U*DG/PRO

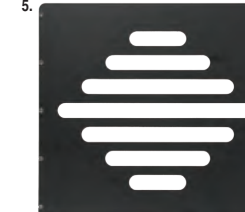

DRAINER GROOVE PRO INNER TEMPLATES Sold separately

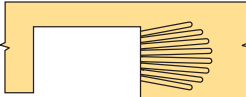
Router carriage not used when templates are fitted.

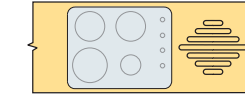
1. 	2. 	3. 	4. 	5. 
Straight Slot	Straight Fan	Curved Fan	Lightning Fan*	Hot Rod (100, 200, 300 & 400mm)
				

SPECIFICATION

Fall _____ 0.5°
 Groove length _____ 17-19/32"
 Router carriage ski working area
 17-19/32" x 16-11/32"
 Guide bush size _____ 1-3/16"
 Size 23-5/8" x 23-5/8" x 15/32"
 Weight _____ 8.8 lbs

INCLUDES

- 1 x Outer frame
- 1 x Ski carriage
- 2 x Index pins

OPTIONAL TEMPLATES

- 1. Straight slot **U*DGP/IP/SS**
 - 2. Straight fan **U*DGP/IP/SF**
 - 3. Curved fan **U*DGP/IP/CF**
 - 4. Lightning fan* **U*DGP/IP/LF**
 - 5. Hot rod **U*DGP/IP/HR**
- * Requires 25/32" guide bush.

OPTIONAL ACCESSORIES

- 6. R3/8" Drain groove cove bit **U*C056AX1/2TC**
- 7. R6mm Hot rod cove bit **U*C053CX1/2TC**
- 8. R1/4" Hot rod cove bit **U*C054AX1/2TC**
- 9. 3/4"Ø Two flute bit **U*C030BX1/2TC**
- 10. 1-3/16" (30mm) **U*GB30**
- 11. 25/32" (20mm) **U*GB20**
- 12. F Clamps **U*FC/200**
- 13. Carry case **U*CASE/DG**



⚠ WARNING - California Proposition 65 - www.P65Warnings.ca.gov - See page 28 & 29 for more information

DOOR HANGING SOLUTIONS

CONTRACTOR SKELETON HINGE JIG

Two piece jig made from lightweight aluminum extrusion for strength. Clean and accurate every time with minimal set-up time, both on-site and in joinery shops.

- Ideal for fitting a new door in an old frame.
- Fully adjustable quick release aperture blocks for use on fire doors and in renovation work.
- Can be used on max. 63/64" thick fixed stops.
- Adjustable stops plus three pre-set stop positions for 25/32", 63/64" and 1 3/16" hinge leaf.
- Suitable for timber based doors and square butt hinges.

Product Reference
U*H/JIG/C



CORNER CHISEL

For squaring hinge recesses.

Product Reference
U*C/CHISEL see page 14



SPECIFICATION

Weight _____ 6.4lbs
Hinge sizes possible
 Length min. _____ 2-5/8"
 Length max. _____ 5"
 Width min. _____ 1/2"
 Width max. _____ 1-3/8"
Door sizes possible
 Height min. _____ 6' 5"
 Height max. _____ 6' 10"*
 Thickness min. _____ 5/8"
 Thickness max. _____ 2"

* For doors over 80-5/16" the bottom hinge will be higher than 9" up.

Hinge recess corners have a 15/64" radius, which will need to be squared off with a corner chisel.

INCLUDES

- 1 x 15/32" Shank router bit
- 3 x Aperture block assemblies
- 4 x Bradawls (short blade)
- 1 x 5/8"Ø screw-in guide bush
- 1 x 5/8"Ø Euro style guide bush
- 1 x Fabric storage case



NEW

ACCESSORY

Screw-on guide bush used to create 1/4" radius hinges when a 1/2" bit is used.

Product Reference
U*GB/US/167



CONTRACTOR HINGE JIG

Two piece contractor hinge jig with adjustable apertures to recess hinges in wooden doors and frames. Constructed from aluminum extrusion, it is easy to use with minimal setting-up time, completing the job accurately and quickly.



- Use on-site and in joinery shops to increase productivity.
- Four apertures for fire door requirements.
- No need for marking out in the conventional way.

Product Reference
U*H/JIG/A



SPECIFICATION

Hinge sizes possible

Length min. _____ 2-5/8"

Length max. _____ 5"

Width min. _____ 3/8"

Width max. _____ 1-3/8"

Door sizes possible

Height min. _____ 6' 5"

Height max. _____ 6' 10"

Thickness min. _____ 5/8"

Thickness max. _____ 2"

* For doors over 80-5/16" the bottom hinge will be higher than 9" up. Hinge recess corners have a 15/64" radius, which will need to be squared off with a corner chisel Ref. U*C/CHISEL.



INCLUDES

- 1 x 15/32" Shank router bit
- 4 x Apertures
- 2 x Bradawls with spacer
- 1 x 5/8"Ø screw-in guide bush
- 1 x 5/8"Ø Euro style guide bush
- 1 x T-handle hex key
- 1 x 5/32" spacing gauge
- 1 x Fabric storage case

NEW

ACCESSORY

Screw-on guide bush used to create 1/4" radius hinges when a 1/2" bit is used.

Product Reference
U*GB/US/167



8 FOOT HINGE JIG

A three piece phenolic plastic hinge jig for 8 foot doors, supplied in a fabric carry case.

- Door size minimum 7' 11" (95") and maximum 8' (96").
- Alloy jointing plates.
- Hinge positions can be set at 4-7/8" down, 30-3/8" down, 55-7/8" down and 81-3/8" down.

Product Reference
U*H/JIG/8FT



SPECIFICATION

Hinge sizes possible

Length min. _____ 2-3/4"

Length max. _____ 5-1/2"

Width min. _____ 3/8"

Width max. ** _____ 1-3/8"

Door sizes possible

Height min. _____ 7' 11"

Height max. _____ 8'

Thickness min. _____ 5/8"

Thickness max. _____ 2"

** A wide hinge can be accommodated if a 1/2" overhang offset is used. Hinge recess corners have a 15/64" radius, which will need to be squared off with a corner chisel Ref. U*C/CHISEL.

INCLUDES

- 1 x 15/32" Shank router bit
- 4 x Bradawls
- 1 x 5/8"Ø screw-in guide bush
- 1 x 5/8"Ø Euro style guide bush
- 1 x T-handle hex key
- 1 x Fabric storage case



DOOR HANGING ACCESSORIES

EASYSCRIBE

A handheld offset pencil line drawing scribing tool with extendable plate.

- Suitable for a multitude of uses, its ease of use and superior ergonomics makes it indispensable for installation contractors.
- Uses include scribing in a door to the frame, scribing countertops, marking architrave offset, marking hinge recess depth, if cut by hand. Ideal for marking out flooring, countertops and tiles.
- Knurled fore grip sliding steel guide plate to allow up to 2" projection.
- Marks narrow pencil line 1/32" wide to ensure accuracy.
- Includes three leads.



Product Reference
U*E/SCRIBE

SPARE PARTS

Graphite Leads
Pack of ten.
U*E/SP/10



DOOR STAND

Holds door on its edge while routing a hinge recess and mortise for locks.

- Allows door to be tilted back to assist fitting into frame.
- Holds door securely while routing, planing and drilling.
- Adjustable clamp for doors 1-1/4" to 2-5/32" thick.
- Maximum door weight 127.8lbs.

Product Reference
U*D/STAND/A



DOOR LIFTER

Foot operated lifter to support door while fitting into frame.

- Slides under door and stays flat and stable until ready to activate the lift with users foot.
- Cam design with internal weight to keep level for ease of use.
- Ideal for pinned hinges.
- Lifts door 1-1/2" high and supports maximum weight 240lbs.

Product Reference
U*D/LIFT/A



DOOR & BOARD LIFTERS

Allows up, down and side to side movement for easy positioning and fixing of doors, panels and plasterboard.

- Foot operated lifter to support door while fitting into door frame, freeing up the users hands.
- Lifts door 2-3/8" high, 360 degree rotation.
- Foot pad protects floors.

Product Reference
U*D/LIFT/B
Standard
max. weight 165lbs

NEW
U*D/LIFT/C
HEAVY DUTY max. weight 440lbs



DOOR CLAMP

Holds door while drilling and fitting locks.

- No set-up time needed.
- Padded to prevent door and floor damage.
- For doors up to 2-3/16" thick.

Product Reference
U*D/CLAMP/A



CORNER CHISEL

For squaring hinge and lock faceplate recesses.

- Spring loaded HSS anvil for a sharp cut and long life, can be resharpened.
- Locates in the rounded corner of the routed recess.
- One square blow with a hammer to square corners.
- Use with Trend Hinge and Lock Jigs.

Product Reference
U*C/CHISEL

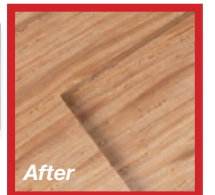
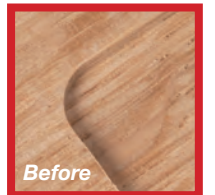

LOCK JIGS

CONTRACTOR LOCK JIG

Uses a set of interchangeable templates to rout the mortise and faceplate recess for popular door locks.

- For most common sash mortise and dead locks, with up to 2-3/4" deep mortises and a 7/8" or 1" faceplate. Deeper mortises can be achieved with a suitable size of auger bit.
- Precision manufactured plates and body.

INCLUDES

- 12 x Face plate templates
- 4 x Mortise templates
- 1 x 1/2" Shank 15/32" router bit
- 1 x 1-3/16" Screw-on guide bush
- 1 x 1-3/16" Guide bush collar



Product Reference
U*LOCK/JIG

CONTRACTOR LARGE LOCK JIG

For routing the faceplate and mortise for larger locks quickly and accurately.

- Equipped with two templates for Baldwin locks with 8" x 1-1/4" and 8" and 1" faceplates.
- Suitable for doors 1-5/16" to 2-1/4" thick.
- An auger bit and drill is required to complete deep mortises.

INCLUDES

- 1 x Adapter plate (to allow smaller templates to be fitted).
- 1 x 1/2" Shank 15/32" router bit
- 1 x 1-3/16" Screw-on guide bush
- 1 x 1-3/16" Guide bush collar



Product Reference
U*LOCK/JIG/A

FULLY ADJUSTABLE TRADE LOCK JIG

For precision fitting of locks into doors. Fits lock faceplates of lengths up to 10".

- Quick and easy to set-up as jig has engraved underside to allow set-up for doors 1-3/8", 1-3/4", 2" and 2-1/8".
- Suitable for doors 1-3/16" to 3-9/64" thick.
- Engraved for 5/8" and 3/4" lock widths and 7/8" and 1" faceplate widths.

INCLUDES

- 2 x Setting blocks
- 1 x 1/2" Shank 15/32" router bit
- 1 x 1-3/16" Screw-on guide bush



Jig requires 1/2" shank router with 3-1/8" plunging capacity and two quick action clamps.

Product Reference
U*LOCK/JIG/B



COMPATIBILITY
www.trend-uk.com/compatibility



trend-uk.com/video

SAFETY AIRSHIELD PRO

Fully protected air circulating face shield for use with woodworking applications including turning, sanding and routing.

Utilized where particulates must be filtered in multiple industries including agricultural applications.

- A built-in quiet fan keeps a constant flow of filtered air across the face.
- Provides excellent protection from inhalation of harmful dust with twin fine dust filters.
- Protects eyes and face against flying debris.
- Filter efficiency 98%.
- Combination face-seal and hood improves protection.
- 8 hour battery.
- On-board battery charging.

Product Reference
U*AIR/PRO

SPECIFICATION

Rating _____ DIY/Craftsman/Professional
Airflow min. _____ 5.6 cf/min
Airflow fully charged _____ 7.06 cf/min
Size of headband _____ 20-1/2"-24-1/2"
Size range _____ 6-3/8"-7-3/4"
Mean filtered particle size _____ 0.6 micron
Motor sound level _____ 70dB
Battery _____ 8 hrs
Weight _____ 2.2 lbs

Eye protection to ANSI Z87+ (High energy impact). Respiratory protection (for reference only) NPF50 to EN 12941 TH2P.

Not NIOSH approved.



8 hour battery

Single rechargeable Ni-MH battery for 8 hours use. Battery needs to be charged whilst fitted to the unit.

INCLUDES

- 1 x 8 Hour battery
- 1 x Battery charger
- 1 x Pair TH2P fine filters
- 1 x Airflow indicator
- 1 x Clear visor overlay
- 1 x Storage bag



ACCESSORY

Remote battery cradle
To allow charging of battery independently from the U*AIR/PRO. Ideal when a spare battery is used.

Product Reference
U*AIR/P/7



REPLACEMENT PARTS

TH2P Filter pack
U*AIR/P/1 (pair)

8 Hour battery
U*AIR/P/4

Charger
U*AIR/P/5L
(120v)

Replacement visor overlay - clear
U*AIR/P/3C
pack of 10



Audible low battery warning

VIDEO TO WATCH



trend-uk.com/video



AIRSTEALTH NEW N100 HALF MASK

New generation N100 half mask, with low profile ergonomic design.

- Less clogging pressure and inward leakage.
- Protects the user against airborne particles, non-petroleum based aerosols, mist, welds and fumes.
- Twin HEPAC* pleat encapsulated design filter provides up to 99.99% filtration of airborne particles and aerosols at 0.3 micron and above.
- Exhalation valve on bottom of face piece, ensuring no exhalation air, steam or fog of any glasses/visors.
- Protective grill covers 100% of filter surface.
- Grill protects filter from moisture and particulates, ensuring it performs better in clogging pressure and filtration efficiency.

Product Reference

U*STEALTH/SM
U*STEALTH/ML

Maximum Filtration

Removes up to 99.97% of airborne particles.

Maximum Breathability

Lowest breathing resistance of any half mask on the market.

8+ HOURS Maximum Comfort

So comfortable it can be worn for 8+ hours a day.



SAFETY

SPECIFICATION

Respiratory Protection _____ N100
Rating _____ DIY/Craftsman/Professional
Assigned Protection Factor _____ APF10
Weight _____ 4.7oz
Conforms to NIOSH N100



trend-uk.com/video

APF10

ASSIGNED PROTECTION FACTOR

INCLUDES

- 1 x Pair N100 filters
- 1 x Storage bag



REPLACEMENT PARTS

- N100 Filter (pair)
- 1 off **U*STEALTH/1**
- 5 off **U*STEALTH/1/5**

- Storage Case
- U*STEALTH/2**

- N100 Nuisance filter (pair)
- 1 off **U*STEALTH/3**
- 5 off **U*STEALTH/3/5**
(Available in early 2020)



Replaceable N100 filters for 99.99% filtration efficiency.



Large non-return valve with integral sample port & plug to allow for non-destructive face fitting.



Clip fastener with adjustable strap.

SIZE GUIDE

Face length (bridge of nose to chin)	3 7/8" - 4 17/64"	4 43/64" - 5 1/16"	M/L	M/L	M/L
	4 17/64" - 4 43/64"	5 1/16" - 5 59/64"	S/M	M/L	M/L
	4 17/64" - 4 43/64"	5 1/16" - 5 59/64"	S/M	S/M	M/L
	3 7/8" - 4 17/64"	4 43/64" - 5 1/16"	S/M	S/M	S/M
			4 3/4" - 5 15/64"	5 15/64" - 5 3/4"	5 3/4" - 6 15/64"

Face width (between the cheek bones)



VARIJIG SYSTEM

VARIJIG SELF CLAMPING GUIDES

Self clamping, straight line clamp guides that use the Varijig low profile extrusion.

- For accurate guiding of routers, saws and jigsaws.
- Low profile extrusion with integral clamping of workpiece, double locking mechanism and two full length T-slots.
- Common Varijig extrusion to 24 inch (610mm), 36 inch (915mm) and 50 inch (1270mm) Clamp Guides.
- Metric and imperial sliding scale.
- Extrusion profile 5/8 inch (16mm) high x 2-1/8 inch (54mm) wide.
- Ref. VJS/CG/PRO8 is an extra wide clamp 5 inch (127mm) with four T-slots. Ideal for large sheet material, clamps up to 96 inches (2.44 metres).
- Jaws have fixing holes for accessories.

Product References

U*VJS/CG/24	24" (610mm)
U*VJS/CG/36	36" (915mm)
U*VJS/CG/50	50" (1270mm)
U*VJS/CG/PRO8	8'-96" (2440mm)



Extra wide clamp
Ref. **U*VJS/CG/PRO8**

VARIJIG FRAME SYSTEM

Adjustable frame and guide for use with a router.

- Adjustable frame for rectangles and squares.
- Allows a router to cut recesses, slots, face panel moulds etc. Can also be used to create panel doors.
- Four lengths of 27-1/2" extrusion with dual metric/imperial measuring scales.
- Working area 23-1/2" x 23-1/2".
- Cross cut accuracy to 5 thou. A square is required to square frame before use.
- Use with a guide bush with minimum 5/16" spigot length, or use Unibase as guide.



Router not included.

Product Reference
U*VARIJIG



trend-uk.com/video

INCLUDES

- 4 x Alloy extrusions with scales
- 4 x Corner brackets
- 1 x Anti-tilt shoe
- 1 x Anti-tilt shoe fixing screw



REPLACEMENT PARTS

- Frame jointing kit
 - Set of four corner jointing brackets.
- U*VJS/FJK**

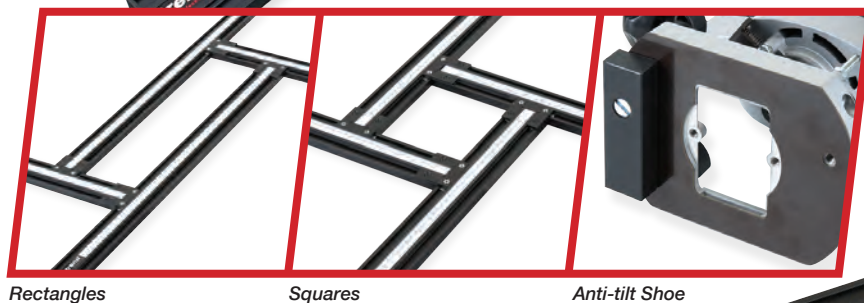

Rectangles

Squares

Anti-tilt Shoe

VARIJIG 100" STRAIGHT GUIDE

For guiding routers, circular saws and jigsaws.

- Two lengths of extrusion with jointing piece to give maximum working length of 100" (2540mm). Reduced length for easier transport and storage.
- Clamps can slide along each extrusion.
- Maximum material clamping thickness 1-1/4".
- Adjustable friction washer on clamps prevent clamp from sliding too freely.
- One extrusion has dual metric/imperial scale.
- Can be combined with Varijig parts.

Product Reference
U*VJS/G/100

INCLUDES

- 1 x 56" Alloy extrusion with scale
- 1 x 56" Alloy extrusion
- 1 x Connecting block
- 1 x Hex key 4mm (5/32")
- 2 x 1-1/4" Sliding friction clamps



Crosscutting Saw not included

VARIJIG EXTRA LONG PIVOT CLAMPS

Pair of pivoting sliding friction clamps with 2" clamping thickness.

- 360 degree clamp rotates to allow the pad of the clamp to be secured firmly to the workpiece.
- The clamp can be used with the Varijig system including the Varijig set, straight guides and angle guide.
- Aluminum body with soft pads to prevent marring of component.
- Friction lock design, so they can be positioned in extrusion without sliding out end when clamp lifted up.

Product Reference: **U*VJS/PCK/L**



OPTIONAL ACCESSORIES FOR VARIJIG SYSTEM

Clamp kits (Fit to extrusions on varijig system)

Pair of sliding friction clamps with 1-1/4" clamping thickness.

U*VJS/CK

Pair of long sliding friction clamps with 2" clamping thickness.

U*VJS/CK/L

Connecting block kit

Jointing block for extrusions.

U*VJS/G/CB

Recommended 1-3/16" guide bush
Euro Style with extra long 3/8" spigot for U*VJS/TG/JIG or U*VARIJIG.

U*GB30/A

Screw-on Style.

U*GB/US/30

Universal sub-base

Certain makes & models of router will require a Unibase to accept the Euro Style guide bush Ref. U*GB30/A.

U*UNIBASE



LED FLASHLIGHTS & HEADLAMPS

NEW

Alloy bodied high quality flashlights and headlamps suitable for all trades.
High grade aluminum body with deep-seated anodizing processing for increased abrasion resistance.



EASY FOCUS PEN FLASHLIGHT

- Innovative and lightweight design.
- Easy focus sunlight.
- Lumileds CRI 90 LED, 50000 hours lifetime.
- IPX4 resistant, impact resistant PC lens.
- Aircraft aluminum body with anodised finish.
- Size : (L) 5-5/16" x (D) 11/16" / 9/16".
- Weight 1.6oz excluding battery.
- 2 x AAA (1.5v) batteries included.

Product Reference
U*TCH/PE/B22



120 LUMENS



BRIGHTNESS	RUN TIME	EASY FOCUS	LUMILEDS	BEAM DIST.	INTENSITY	DROP RESIS.	ANSI FL1	BATTERY
120 LUMENS	2h		CRI 90	61Yds	800cd	39-3/8"	IPX4	2x AAA (1.5v) INCLUDED

ANGLE TWIST FLASHLIGHT

- One button control: Low-High. Long press (2 secs): UV light.
- Rechargeable with micro USB port.
- Innovative angle twist head design.
- Cree LED, 50000 hours lifetime.
- IPX4 resistant, impact resistant PC lens.
- Strong magnet in base and pocket clip.
- Aircraft aluminum body with anodised finish.
- Size: (L) 6-5/16 x (D) 1-13/16" / 1-1/16".
- Weight: 5.5oz excluding battery.
- Storage pouch and USB cable included.
- 1 x 18650 Li-Ion (2600 mAh) battery included.

Product Reference
U*TCH/AT/B75R



300 LUMENS



LOW MODE	HIGH MODE	CREE LED	BEAM DIST.	INTENSITY	UV	DROP RESIS.	ANSI FL1	MAGNETIC	USB RECHARGE
90 LUMENS	300 LUMENS	XP-G2 S2	87yds	1600cd	UV	39-3/8"	IPX4		



ANGLE HEADLAMP

- Innovative, lightweight and comfortable design with quick dismount.
- One button control: High-Low. Long press (2 secs): Strobe-SOS.
- Cree LED, 50000 hours lifetime.
- Quick change light mode.
- IPX4 resistant, impact resistant PC lens.
- Aircraft aluminum body with anodizing finish.
- High efficiency PCB, for safety and reliability.
- Strong magnet & pocket clip for hands free work.
- Size: (L) 2-7/8" x (D) 1-1/4".
- Weight: 2.7oz excluding battery.
- 1 x AA (1.5v) battery included.

Product Reference
U*TCH/HA/H10



LOW MODE 30 LUMENS 5.5h	HIGH MODE 115 LUMENS 1h 15min	CREE LED XP-E2 R3	BEAM DIST. 78Yds	INTENSITY 1300cd	DROP RESIS. 39-3/8"	ANSI FL1 IPX4	MAGNETIC	BATTERY 1x AA (1.5v) INCLUDED	ANTI-SLIP
--------------------------------------	--	-----------------------------	----------------------------	----------------------------	-------------------------------	-------------------------	-----------------	---	------------------

PIVOT HEADLAMP

- Innovative, lightweight and comfortable design with pivoting head.
- One button control: Low-Middle-High. Long press (2 secs): Max-Strobe-SOS.
- Cree LED, 50000 hours lifetime.
- Water resistant 2M, impact resistant PC lens.
- Aircraft aluminum body with anodizing finish.
- High efficiency PCB, for safety and reliability.
- Size: (L) 2-1/2" x (D) 1-23/32" x (W) 1-23/32".
- Weight: 3.6oz excluding battery.
- 3 x AAA (1.5v) batteries included.

Product Reference
U*TCH/HP/H20



LOW MODE 30 LUMENS 40h	MIDDLE MODE 60 LUMENS 15h	HIGH MODE 160 LUMENS 4h 30 mins	HIGH MODE 350 LUMENS 4h	BATTERY 3x AAA (1.5v) INCLUDED
CREE LED XP-G2 S2	BEAM DIST. 164Yds	INTENSITY 5000cd	DROP RESIS. 78-3/4"	STROBE
SOS	WATERPROOF 6'-6"	ANTI-SLIP & TOP BAND		

PROFESSIONAL ROUTER BITS



Micrograin Carbide Tipped router bits for use on hardwood, softwood, fiberboard, plywood and particle board.

- Micrograin Carbide Tips to ensure a perfect sharpness for extra life.
- Bits made to European Safety Standard EN847-1/2 which ensures quality materials are used. The tools are balanced and with round form to reduce user injury.
- Two fluted unless specified otherwise.



STRAIGHT FLUTED TCT TWO FLUTE

TUNGSTEN CARBIDE TIPPED

Suitable for a wide range of applications such as engraving, grooving, rebating and shallow mortising.

- Use on softwoods, hardwoods, MDF, plywood and chipboard.
- All bits have a bottom cut feature.
- Metric diameters from 2mm to 50mm.

Product Ref.	D mm	D inch	C mm	C inch	OL mm	OL inch	Shank Dia. 1/4" 1/2"
U*C001C	2	5/64	5	13/64	55.5	2-3/16	✓ -
U*C001A	3	-	9.5	3/8	56.5	2-7/32	✓ -
U*C002	4	5/32	11.1	7/16	60	2-3/8	✓ -
U*C004	5	13/64	16	5/8	71.5	2-7/8	✓ -
U*C005	6	15/64	16	5/8	61	2-3/8	✓ ✓
U*C008	6.3	1/4	25.4	1	68.5	-	✓ -
U*C011	7.9	5/16	19.1	3/4	-	-	✓ -
U*C012	7.9	5/16	25.4	1	68.5	-	✓ -
U*C012A	8	5/16	25	63/64	-	-	✓ -
U*C012B	9	23/64	19	3/4	59.5	2-5/8	✓ ✓
U*C015	9.5	3/8	31.8	1 1/4	72.5	-	✓ -
U*C016C	10	25/64	25	1	58	-	✓ -
U*C019A	12	15/32	19	3/4	-	2-3/4	✓ -
U*C172	12	15/32	63	2-15/32	-	4-3/8	- ✓
U*C021A	12.55	31/64	25.4	1	-	-	✓ -
U*C021	12.7	1/2	25.4	1	-	-	- ✓
U*C022	12.7	1/2	31.8	1-1/4	72.5	-	✓
U*C153D	12.7	1/2	50	2	93	3-5/8	- ✓
U*C164	12.7	1/2	63	2-1/2	105	4-9/64	- ✓
U*C023A	14	35/64	19	3/4	59.5	-	✓ -
U*C024A	15	19/32	25	63/64	65.5	-	✓ -
U*C026	15.9	5/8	25.4	1	75.5	-	✓ -
U*C025A	16	5/8	19	3/4	60	-	✓ -
U*C028B	18.2	23/32	19	3/4	60	2-3/8	- ✓
U*C030B	19.1	3/4	50	2	92	3-5/8	- ✓
U*C030A	20	25/32	20	25/32	60	2-3/8	- ✓
U*C033A	25	63/64	19	3/4	59.5	-	✓ -
U*C033E	26	1-1/32	25	1	63.5	-	- ✓
U*C033G	28	1-7/64	25	1	64	-	- ✓
U*C033H	28.5	1-1/8	25	1	67	2-19/32	- ✓
U*C033J	30	1-3/16	25	1	67	-	- ✓
U*C033K	31.8	1-1/4	25	1	63.5	2-1/2	- ✓
U*C033N	35	1-3/8	25	1	67	-	- ✓
U*C033Q	40	1-37/64	25	1	66	-	- ✓
U*C033W	50	1-31/32	25	1	64	-	- ✓

TWO FLUTE METRIC SCALE



Suitable for a wide range of applications such as engraving, grooving, rebating and shallow mortising.

- Use on softwoods, hardwoods, MDF, plywood and chipboard.
- All bits have a bottom cut feature.

Product Ref.	D mm	D inch	C mm	C inch	OL mm	OL inch	Shank Dia. 1/4" 1/2"
U*C016S	10	25/64	19.1	3/4	60	2-3/8	✓ -
U*C021S	12.7	1/2	25.4	1	68	2-5/8	✓ ✓
U*C153S	12.7	1/2	50	2	98.5	3-5/8	- ✓

TRIMMING FLUSH TRIM

TCT
TUNGSTEN
CARBIDE
TIPPED

Used for trimming plastic or plywood overlays.

- Also for copy profiling with a template.

Product Ref	D mm	D inch	C mm	C inch	B mm	A degrees	Shank Dia. 1/4" 1/2"
U*C167	6.35	1/4	12.7	1/2	6.35	90	✓ -
U*C168	6.35	1/4	25.4	1	6.35	90	✓ -
U*C115A	9.5	3/8	25.4	1	9.5	90	✓ -
U*C116	12.7	1/2	25.4	1	12.7	90	✓ ✓
U*C195	12.7	1/2	50	2	12.7	90	- ✓
U*C117	15.9	5/8	15.9	5/8	15.9	90	✓ -
U*C117A	19.1	3/4	25	1	15.9	90	- ✓
U*C117B	19.1	3/4	50	2	15.9	90	- ✓



GUIDED TEMPLATE PROFILER

Shank mounted bearing profilers are ideal for template guidance.

- Use for rebating and trimming edges only.

Product Ref	D mm	D inch	C mm	C inch	B mm	A degrees	Shank Dia. 1/4"
U*C121B	12.7	1/2	9.5	3/8	12.7	90	✓
U*C121	12.7	1/2	25.4	1	12.7	90	✓
U*C166	19.1	3/4	50	2	19.1	90	✓

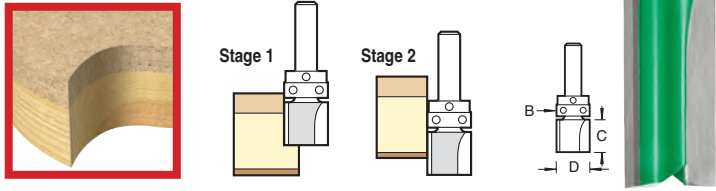

ROUTER DRILLING ROUTER DOWEL DRILLS

TCT
TUNGSTEN
CARBIDE
TIPPED

Metric dowel drills with diameters from 3mm to 10mm.

- These drills are used for shelf supports.
- The speed range is 1000 to 22000 rpm.
- Ref. U*C174 can be used with the Trend Shelf Support Template.
- Refs. U*C175, U*C176 & U*C177 can be used for 6, 8 & 10mm dowels.

For details of Shelf Support Template see page 26.

Product Ref	D mm	C mm	C inch	OL mm	OL inch	Shank Dia. 1/4"
U*C180	3	14	35/64	57	2-1/4	✓
U*C222	4	35	1-3/8	57	2-1/4	✓
U*C174	5	35	1-3/8	57	2-1/4	✓
U*C175	6	35	1-3/8	70	2-3/4	✓
U*C176	8	35	1-3/8	70	2-3/4	✓
U*C177	10	35	1-3/8	70	2-3/4	✓



TCT
TUNGSTEN
CARBIDE
TIPPED

DOVETAILS STAIR TRENCHING

Made for stair housing jigs with right hand rotation.

- Ensures tight fit of tread in string.

Product Ref	D mm	D inch	C mm	C inch	OL inch	A degrees	Shank Dia. 1/2"
U*C240	13.5	17/32	20	3/4	2-9/16	95	✓
U*C241	16	5/8	26	1	2-9/16	95	✓
U*C242	19	3/4	25.5	1	2-9/16	95	✓
U*C243	22	7/8	26	1	2-9/16	95	✓

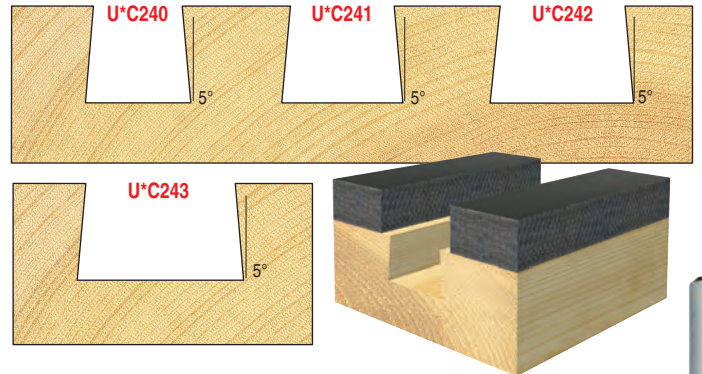

TWO FLUTE DOVETAILS

Produce tight reliable joints for drawers, boxes etc.

- Ref U*C154 has a Solid Carbide insert.
- Can be used with U*CDJ300 & U*CDJ600 dovetail jigs.
- To suit user preference, the table shows angles from the horizontal and the profiles show angles from the vertical.

Product Ref	D mm	D inch	C mm	C inch	OL mm	OL inch	A degrees	Shank Dia. 1/4" 1/2"
U*C154	6	15/64	6.9	9/32	57.5	2-1/4	98	✓ -
U*C041A	12.7	1/2	12.7	1/2	61	2-3/8	104	✓ -
U*C178	12.7	1/2	20	25/32	60	2-3/8	98	✓ -
U*C179	19.1	3/4	25	63/64	65	2-9/16	97	- ✓

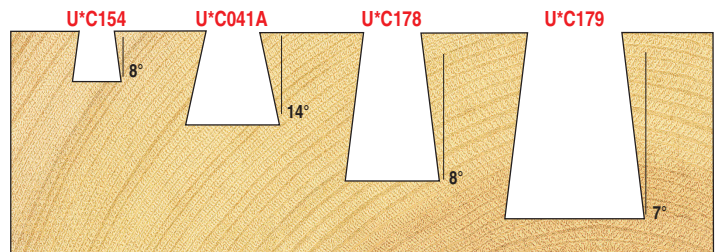

EURO HINGE BIT HIGH SPEED 35MM

TCT
TUNGSTEN
CARBIDE
TIPPED

This machine bit has a specially designed form of scribe to allow use at high speeds.

- For recessing circular hinges.
- For repetitive routing, a template and guide bush fitted to the router base should be used.

Product Ref	D mm	D inch	OL mm	OL inch	Shank Dia. 1/2"
U*C250	35	1-3/8	60	2-3/8	✓

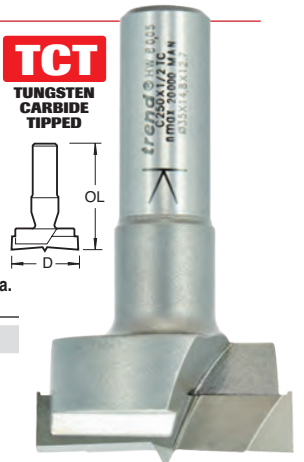

SLOTING & GROOVING BISCUIT JOINTER SET



This two wing self-guiding Micrograin Carbide Tipped slotting bit is ideal for biscuit jointing.

- The set is supplied with three ball bearing guides to suit the three sizes of biscuits available.
- A slightly longer cut than the length of the biscuit is required for ease of alignment during assembly.

For details of wooden biscuits see opposite.

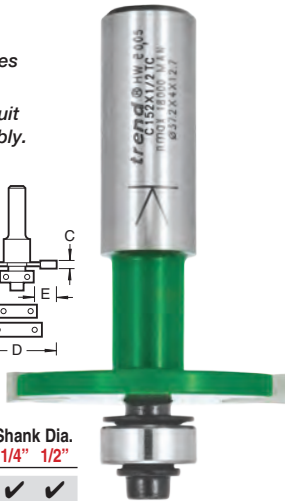
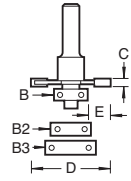

Product Ref	C mm	C inch	D mm	B mm	B inch	Shank Dia. 1/4" 1/2"
U*C152	4	5/32	37.2	12.7	1/2	✓ ✓

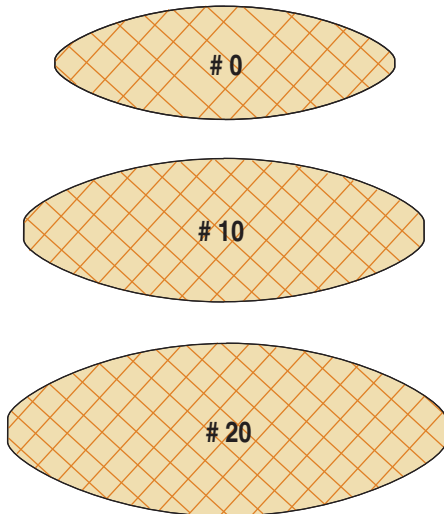
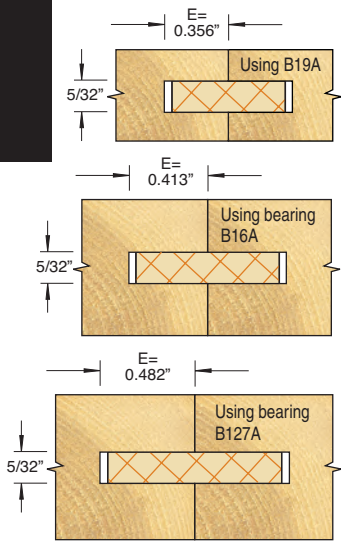

SLOTING BIT

Two wing Micrograin Carbide Tipped slotting bits. A 1/2-inch diameter bearing is supplied with every bit giving a 3/8-inch groove depth.

Depth of cut can be changed by purchasing alternative bearing sizes. Easy to set-up and use, hex key is supplied.

N.B. The grooving section cannot be detached from the shank.



Product Ref	C mm	C inch	D mm	D inch	B mm	B inch	E inch	Shank Dia. 1/4" 1/2"
U*C143	3.2	1/8	31.8	1-1/4	12.7	1/2	3/8	✓
U*C144	4.7	3/16	31.8	1-1/4	12.7	1/2	3/8	✓
U*C145	6.3	1/4	31.8	1-1/4	12.7	1/2	3/8	✓
U*C146	8	5/16	31.8	1-1/4	12.7	1/2	3/8	✓
U*C147	9.5	3/8	31.8	1-1/4	12.7	1/2	3/8	✓

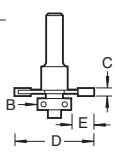
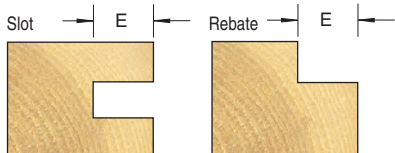

RADIUS & COVE CORE BOX



This is ideal for engraving and decorative panel work.

- Made with Solid Tungsten Carbide insert, with two flutes.

Product Ref	R mm	D mm	C mm	C inch	OL mm	OL inch	Shank Dia. 1/2"
U*C051A	2.5	5	13	1/2	66	2-9/16	✓



EDGE MOULDING CORNER BEAD



Attractive edge moulds.

- Produce a full corner bead by making a second pass at 90°.

Product Ref	R mm	R inch	D mm	D inch	D2 inch	C mm	C inch	B mm	Shank Dia. 1/4" 1/2"
U*C130	4.8	3/16	26	1-1/32	7/8	16	5/8	15.9	✓ -
U*C215	7	9/32	31.9	1-1/4	1 1/8	22.5	7/8	16	- ✓

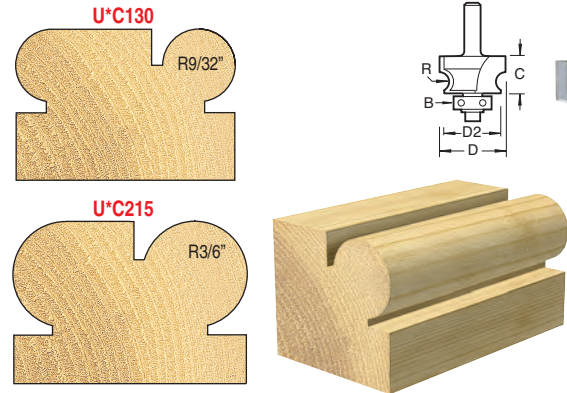

STAFF BEAD

These staff bead bits are ideal for producing nosings and attractive edges. Edge cut only.

Product Ref	R mm	R inch	D mm	D inch	C mm	C inch	OL inch	Shank Dia. 1/4" 1/2"
U*C070	5.2	13/64	20	25/32	19.1	3/4	2-1/4	✓ -
U*C070B	8	5/16	27	1-1/16	30	1-3/16	2-3/8	- ✓
U*C070C	10	25/64	33	1-19/64	35	1-3/8	2-7/8	- ✓
U*C070E	12.7	1/2	42.9	1-11/16	40	1-9/16	3-5/64	- ✓

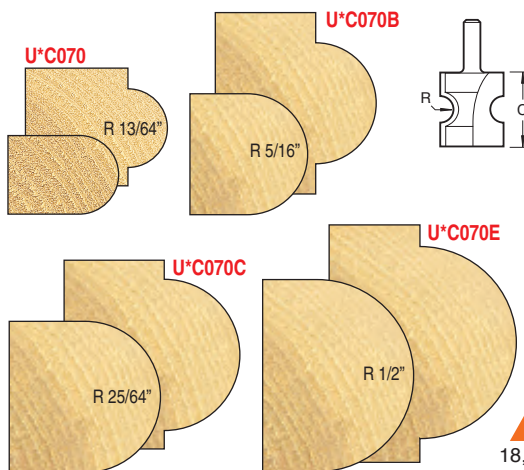

18,000

⚠ For stationary machines at max. recommended speeds as indicated.

ROUNDING OVER BEARING GUIDED ROUND OVER

TGT
TUNGSTEN
CARBIDE
TIPPED

NEW

For producing beads and rounding over edge moulds.

- The set is supplied with two ball bearing guides.
- Use the larger bearing for a round over.

Product Ref	R mm	R inch	D mm	D inch	C mm	C inch	OL mm	OL inch	B mm	B inch	B2 mm	B2 inch	Shank 1/4"
U*C074	3.2	1/8	19	3/4	9.5	3/8	61	2-3/8	9.5	3/8	12.7	1/2	✓
U*C076	6.3	1/4	25.4	1	12.7	1/2	64	2-1/2	9.5	3/8	12.7	1/2	✓
U*C078	9.5	3/8	31.7	1-1/4	15.9	5/8	67.5	2-5/8	9.5	3/8	12.7	1/2	✓
U*C079	12.7	1/2	25.4	1-1/2	19	3/4	70.5	2-3/4	9.5	3/8	12.7	1/2	✓

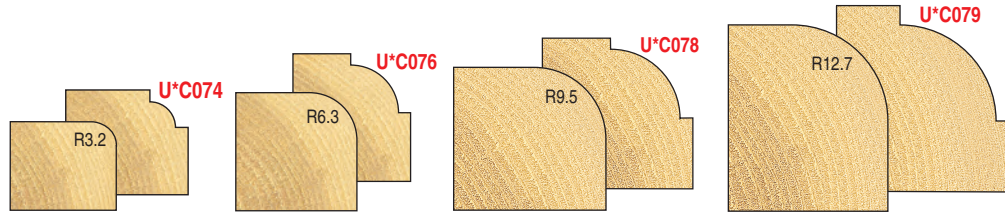
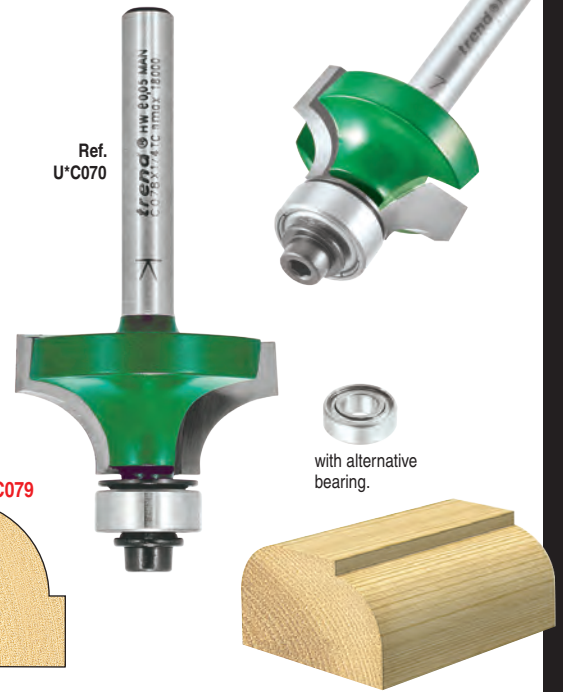
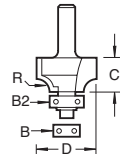

BEARINGS 3/16" BORE

Bearings are shielded to prevent penetration of dust and grease packed for life.

- They should not be cleaned with solvent or lubricated as this will dissolve the grease and cause premature failure.
- Scrape off any resin build-up.
- Always check the tightness of the fixing screw before using bit.

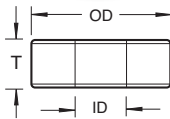

Product Ref	OD mm	OD inch	ID mm	ID inch	T mm	T inch
U*B127A	12.7	1/2	4.76	3/16	4.76	3/16
U*B16A	15.9	5/8	4.76	3/16	4.76	3/16
U*B19A	19.05	3/4	4.76	3/16	4.76	3/16

COLLET EXTENSIONS

For use in router tables where there is limited router bit shank length available.

- Precision machined one-piece steel body with a 1/2" shank, fitted with a multi-slit spring steel collet and collet nut.
- Increases bit spindle length by 2".
- Maximum tool diameter 1-31/32". Requires 3/4" & 7/8" A/F spanners.

Product References:

- U*CE/127127 Collet extension 1/2" shank & collet
- U*CE/127635 Collet extension 1/4" shank & collet
- U*CE/CNS/635 Collet & nut set 1/4"
- U*CE/CNS/127 Collet & nut set 1/2"
- U*CE/NUT Spare collet nut



WOODEN BISCUITS

NEW

Ideal for jointing kitchen countertops.

- Biscuit jointing has proven to be one of the strongest, fastest, safest and most accurate ways to join hardwoods and softwoods, plywood, composition board etc.
- Compared to dowelling, biscuit jointing is faster and more precise.
- The biscuits are made of die-cut beech which expands when in contact with a woodworking adhesive eg. PVA glue.

Product References:

- #.0
For board thickness 5/16" - 15/32"
Size: 1-7/8" x 39/64" x 5/32"
U*BSC/0/100 (qty 100)
U*BSC/0/1000 (qty 1000)
- #.10
For board thickness 33/64" - 45/64"
Size: 2-1/8" x 3/4" x 5/32"
U*BSC/10/100 (qty 100)
U*BSC/10/1000 (qty 1000)
- #.20
For board thickness 3/4"+
Size: 2-3/8" x 29/32" x 5/32"
U*BSC/20/100 (qty 100)
U*BSC/20/1000 (qty 1000)
- #.0, 10 and 20
Qty #.0 x 30, #.10 x 30 and #.20 x 40
U*BSC/MIX/100 (qty 100)
Qty #.0 x 250, #.10 x 250 and #.20 x 500
U*BSC/MIX/1000 (qty 1000)

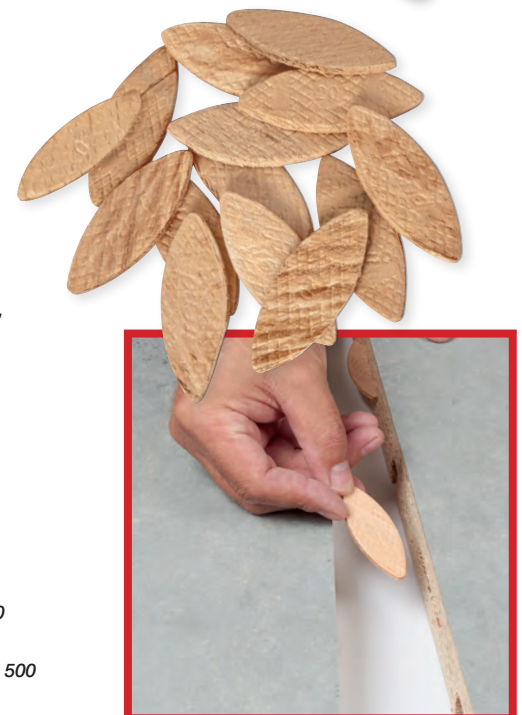

SHELF SUPPORT TEMPLATE

Allows routing or drilling of 32mm "Euro" centre holes for 5mm diameter shelf supports.

- Made from clear plastic, with graduation scales.
- Adjustable clamping bar with two locking knobs.
- Can be used with MDF, timber and particle board.
- A Unibase may be required for certain makes and models of router.

Product Reference

U*TEMP/SS/A Size: 19-11/16" x 5-1/8" x 5/16"



INCLUDES

- 12 x Plain metal shelf supports
- 1 x Knurled repeat index pin
- 1 x 9.5mm guide bush



SHELF SUPPORTS

Metal
With rubber sleeve to protect glass.
Pin: 13/64"Ø (5mm) x 21/32"OL
U*SS/M5/12 (pack of 12)

Brass plated
Pin: 13/64"Ø 5mm x 29/32"OL
Load capacity 220.5lbs (100kg)
U*SS/B5/12 (pack of 12)

Plastic
Load capacity 220.5lbs (100kg)
U*SS/P5/12 (pack of 12)

SUITABLE TOOLS

5mmØ recommended Bit
CraftPro router drilling bit.
U*C174X1/4TC

Shelf support drill bit guide
A quick release shank lip and spur 5mm HSS drill bit guide, which when used with template will allow 5mm diameter blind holes to be drilled for shelf supports.

U*TEMP/SSD/5MM



NEW

NEW



trend-uk.com/video

ROUTER POD

A simple and effective accessory designed to keep your router in a safe upright position when not in use.

- Protects the cutter and guide bush.
- Gives fast, easy access when you are ready to rout.
- Stack double for extra long cutters.
- Anti-slip rubber feet for a secure grip.

Product Reference

U*R/POD/A



TOOL CLEANER

Industrial grade cleaner to remove pitch and resin build-up from sawblades, router bits and planer blades.

- Acts as an excellent lubricant, provides rust and corrosion protection therefore increasing tool life.
- Biodegradable, earth and human friendly. Non-toxic and non-flammable.
- Has unique properties which breaks the molecular bond and lifts the dirt from the tool as opposed to eating away the dirt like citrus cleaners and other chemicals.



Product References

U*CLEAN/500
Pump action spray bottle, size 18 fl.oz. (532ml).

U*CLEAN/5GAL
5 gallon bucket (to special order)

U*CLEAN/55GAL
55 gallon drum (to special order)



trend-uk.com/video



NEW

UNIVERSAL COUNTERSINK

- Clamps onto any drill between 1/8" and 9/32" in diameter.
- For wood and man-made boards.
- By flipping the countersink it can be used as a non-cutting depth stop.
- The drill passes through the body of the countersink and is secured by two hex screws which clamp the countersink onto the drill at the required position.
- ▲ Ensure flutes of drill are aligned with flutes of countersink.
- ▲ Not suitable for production applications or for metals. Not for use with routers.

TCT
TUNGSTEN CARBIDE TIPPED

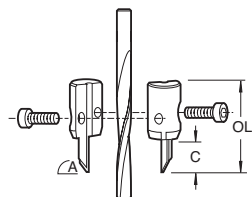
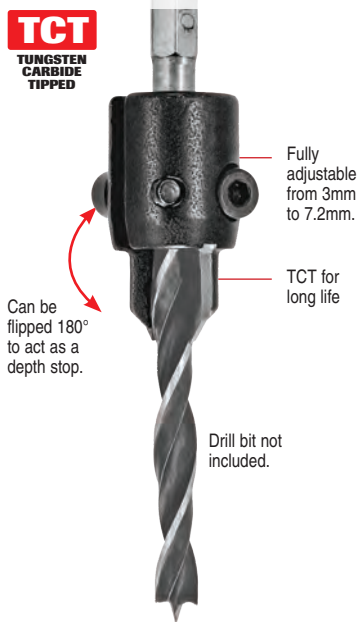

Product Ref	A Deg.	C inch	OL inch
U*UNI/CS	45°	15/32	1-1/4

SPARE PART

Hex key & two screws **U*SP-O**



MEASURING & MARKING

DIGITAL LEVEL BOX

Find the angle on a surface quickly and accurately. Ideal for table and mitre saws.

- Automatic LCD large backlight for easy reading.
- Measures in relative and absolute measurements.
- Working range of angle measurement 4 x 90°.
- Automatic digital inversion for overhead measurements.
- Magnetic base for hands free use.
- Zero button to determine the angle change from initial measurement.

SPECIFICATION

Read out accuracy for all angles $\pm 0.2^\circ$
 Resolution 0.1°
 Auto shutdown time 5 minutes
 Auto shutdown backlight 30 seconds
 Size 2-21/64" x 2-21/64" x 17/64"
 Weight 2.9oz

INCLUDES

- 1 x AAA 1.5V Battery
- 1 x Fabric Pouch



NEW

ANGLE SENSOR TECHNOLOGY



Product Reference
U*DLB

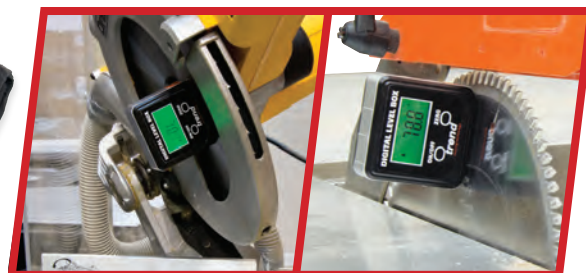

Magnetic base

Large back light

MULTISCRIBE

A profile matching tool used to transfer contours from one shape to another and marks onto various materials.

- 15 functions including parallel scribe, convex scribe, contour profile scribing and line block.
- For use by all trades, carpenters, joiners and builders etc.
- Built in spirit level & pencil sharpener.
- Steel blade with 13/64" and 1/4" graduations for profiling.



Product Reference
U*MS/PRO



DEPTH GAUGE

Metal rule depth gauge to help set the height of router bits and sawblades with greater accuracy.

- Horizontal and vertical measuring.
- For hand routers, router tables and saw benches.
- 2-3/8" wide aperture and accurate to 1/32".
- 3-3/16" measurement range.
- U section plastic injection moulding with unique cam lever lock.
- Steel rule with dual metric and imperial scale.
- Self-standing for setting bit depth on router tables and low profile for backfence adjustment.

Product Reference
U*GAUGE/1



METRIC & IMPERIAL DIGITAL DEPTH GAUGE

Horizontal and vertical measuring.

- For hand routers, router tables and saw benches.
- LCD readout for mm, inches and fractions with auto shut off 5 mins.
- Removable pin to allow hole depths to be measured. Pin can be parked on arm. Hole depth 2".
- Self standing with magnetic feet and flat back.
- Injection plastic moulding with plastic rule.
- Read-out has relative co-ordinate and absolute function.
- 2-3/8" wide aperture.

Product Reference
U*GAUGE/D60



REPLACEMENT PART

Battery CR2032 3v
U*BAT/CR2032/3V



California Proposition 65

Some products sold in this catalog and on our website, may contain chemicals or materials listed on the Proposition 65 Harmful substance list. For details, please see individual product webpages for full safety sheets and certifications. If you would like to find out more information on Proposition 65 and what it means, please visit the official Prop65 information website www.P65Warnings.ca.gov

Please note: The following links take you to an external website, Trend Machinery & Cuttings Tools Ltd, can not be held responsible for the content of third party websites.



Wood Dust

WARNING: Drilling, sawing, sanding or machining wood products can expose you to wood dust, a substance known to the State of California to cause cancer. Avoid inhaling wood dust or use a dust mask or other safeguards for personal protection. For more information go to www.p65warnings.ca.gov/wood



Diamond Sharpening, Hand Tools.

WARNING: The metal parts of this product contain Nickel compounds, a substance known to the State of California to cause cancer. None of these products are to come in contact with food and drinking water. Please wash your hands with soap and water after touching these products. For more information go to www.p65warnings.ca.gov

DIGITAL ANGLE RULES

Calculates angles quickly and accurately.

- Digital display for angles.
- Two sizes 7" and 18-1/2" with two stainless steel rules with metric and imperial scale.
- Measuring range from 000.0° to 360.0° with an accuracy of 0.3°.

Product Reference
U*DAR/200 Size: 7"



Product Reference
U*DAR/500 Size: 18-1/2"



8" DIGITAL ANGLE FINDER

Calculates angles from 0° to 220°. Robust lightweight aluminum construction with 2" wide folding metal blade and locking function.

- Easy operation with three buttons on/off, hold and zero/ABS.
- Use on internal and external angles.
- Readout reads correctly when used in relative mode, and locks in ABS mode.
- Dual metric and imperial scale, with 90° angle checker on end of blade.
- Angles up to 360° can be reached when locking knob is removed.

Product Reference
U*DAF/8



trend-uk.com/video

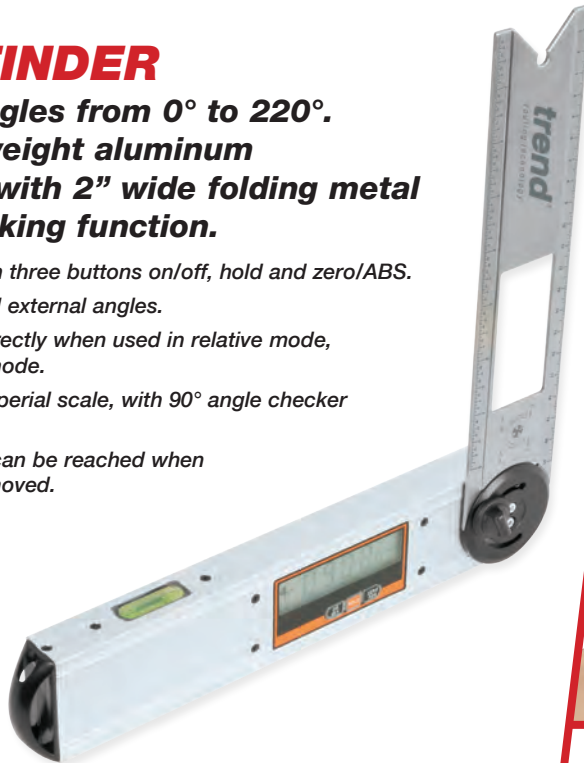

SPECIFICATION	
Weight	12.4oz
Measuring range	0.000° to 220.0°*
Accuracy	0.15°
Resolution	0.05°
Auto shut off (LCD)	After 5 mins
* Reaches 360° when locking knob is removed	

INCLUDES	
1 x	Battery CR2032 3v



COPYRIGHT

© 2019 Trend Routing Technology Inc. All rights reserved. No part of this publication may be reproduced or transmitted without prior permission. Trend Routing Technology Inc. cannot be held liable for any material rendered unusable, or for any form of consequential loss. The descriptions specifications and other claims made with respect to the products featured in this catalog are made as of the date of printing. Trend Routing Technology Inc. retains the right to discontinue production of or make improvements or other changes to any of its products without notice. Product packaging and other product literature should be consulted for current descriptions specifications and other claims relating to Trend Routing Technology Inc. products. Improvements or other changes to products shall not obligate Trend Routing Technology Inc. to make corresponding improvements or changes to products previously manufactured or sold. All Trademarks Acknowledged.

GUARANTEE TREND LIMITED TOOLING WARRANTY

All Trend tools are engineered and manufactured to the highest standards for optimum performance and service life. Trend warrants to the original purchaser at retail that each new Trend tool shall be free from defects in material and workmanship, subject to the guidelines below. Upon verification of failure or malfunction, Trend shall, at its option, within 28 days, repair or replace the tool. Subject to the guidelines below.

Guidelines

1. In the event of failure or malfunction, return the product, properly packaged and postage prepaid, to Trend Routing Technology Inc.
2. All implied warranties for Trend's power tools (INCLUDING MERCHANTABILITY AND FITNESS FOR PARTICULAR PURPOSE) are limited to the period of one year from the purchase date. Some states do not allow limitations on how long an implied warranty lasts, so the above limitation may not apply to you.
3. A warranty claim shall be limited to repair or replacement as stated in Trend's Limited Tool Warranty and in no event shall Trend be liable for any other direct, indirect or consequential damages, costs or expenses. INCIDENTAL AND CONSEQUENTIAL DAMAGES ARE EXCLUDED UNDER ALL WARRANTIES. Some states do not allow the exclusion or limitation of incidental or consequential damages, so the above may not apply to you.
4. Trend warranties give you specific legal rights, and you may also have other rights, which vary from state to state.
5. Trend warranties shall not be deemed to have failed their essential purpose while Trend is willing to repair or replace defective products.
6. Trend assumes no liability for defects or damage caused by abuse or misuse of any product or unauthorised service of any product. The product must have been used for its recommended purpose and not modified by sharpening or other changes. Normal wear and tear are not covered under Trend warranties.
7. Any action for breach of warranty must be commenced within one year after the accrual of the cause of action.

! Lapping Fluid

WARNING: This Petroleum based product can expose you to chemicals including Toluene and Benzene, which are known to the State of California to cause cancer and birth defects or other reproductive harm. For more information go to www.p65warnings.ca.gov/petroleum

! Air Circulating Face Shield and Accessories

WARNING: This product can expose you to chemicals including Bisphenol A, which is known to the State of California to cause birth defects or other reproductive harm. For more information go to www.p65warnings.ca.gov

! Honing Compound

WARNING: This product can expose you to Titanium Dioxide, which is known to the State of California to cause cancer. For more information go to www.p65warnings.ca.gov

ESSENTIAL DIAMOND SHARPENING KIT

NEW

Everything needed to flatten, hone and polish plane irons, knives and chisels.



8" x 3" Double-sided Bench Stone



Leather Strip



Lapping Fluid



Mirror Paste



Cleaning Block



Product Reference
U*DWS/KIT/H



Available from:



Trend Routing Technology Inc.
7351 West Friendly Avenue
Suite A
Greensboro, NC 27410

Telephone Toll Free _____ (877) 918-7363
Retailer & Wholesaler Sales _ (336) 292-5051
Technical Support _____ (336) 292-5051
General Fax _____ (336) 292-5061
Email _____ sales@trend-usa.com
Web _____ www.trend-usa.com

SIGN UP FOR ENEWS
www.trend-usa.com

 **FACEBOOK**
[/TrendRoutingTechnology](https://www.facebook.com/TrendRoutingTechnology)

 **YOUTUBE**
[/TrendRouting](https://www.youtube.com/TrendRouting)

 **TWITTER**
[@TrendRouting](https://twitter.com/TrendRouting)

trendTM
tool technology