

IN Profile

2 ISSUE
AUTUMN 98

The magazine for all Trend Users

**Joint
winner**

The new DJ300
Dovetail Jig

**Latest
new products**

**Black
magic**

Introducing the new
T5 router

**Routing
innovations**

Using the Pivot Frame Jig

**A Cut
above the rest**

Choosing the right sawblade

trend[®]
routing technology

THE NEW FORCE IN SAWBLADES

Trend **WAVEFORM**[®] Sawblades are the product of extensive research into the needs of today's professional and industrial sawblade users.

Designed to out-perform any other TCT sawblades, they are manufactured using the latest technologies and materials to offer outstanding value.

WAVEFORM[®] Sawblades are available from your nearest Trend stockist. Full details of the complete range are in our new Catalogue out now.

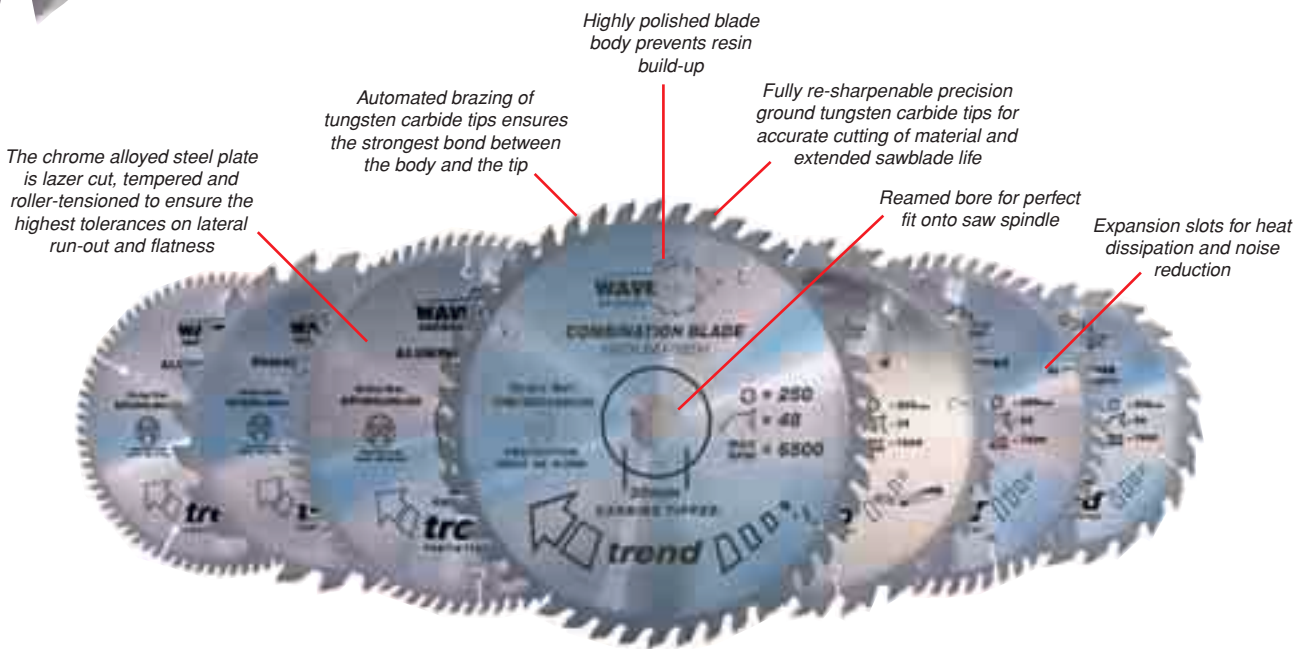

in this issue



- 4 Length Wise**
A simple method of producing children's toys by the metre
- 6 New Products**
A selection of new Trend products launched this Autumn



- 8 Windows For Woodworkers**
An insight into the latest generation of affordable CNC machines

- 10 Routing Innovations**
Routing techniques made possible with the Pivot Frame Jig



- 12 Past and Present**
Jim Phillips explains how the router cutters have developed over the years

- 13 Furniture Focus 2**
Tom Rogers describes how to enhance an item of furniture simply by using the Routercarver

- 14 Dovetail Jig**
Techniques for using the new DJ300 Dovetail Jig

- 16 T5 Router**
A preview of the new T5 variable speed router

- 18 A Cut Above The Rest**
Neil McMillan offers general advice on selection, use and care of sawblades

- 22 Comb Jointing**
Jeremy Broun reveals the secrets behind Comb Jointing

- 26 Routing Workshop**
Additional features are shown for the routing bench constructed in issue one

- 29 On Site 2**
Miles Davey explains how to fit a mortise lock with a dedicated jig and a router

- 30 On Course**
A case study and national guide to sponsored routing courses around the UK

Welcome to issue two of **INProfile**, the magazine for Trend users. This issue has timed nicely with the launch of many new products. The most notable being the launch of the new T5 router and the DJ300 dovetail jig. They are certain to become popular items for the workshop and I have therefore provided a number of articles on these products.

We thank all those that wrote in and again offer the opportunity to all readers to participate in the continuing success of **INProfile** by sending in their tips, comments and questions.

John Perkins
Editor



Editor John Perkins
Technical advisors Miles Davey
Neil McMillan Jim Phillips Tom Rogers
John Tigg

Design/layout Tracy Highland
Emma Hughes Neal Martinez

Illustrators Annette Kelly Dave Scammel

Contributors Jeremy Broun Jack Cox
John Harrington Gordon Warr

Photography Front Cover - Photoworks
TPS Fotoart Matthew Shepherd

Trend Machinery & Cutting Tools Ltd
FREEPOST Penfold Works Imperial Way
Watford England WD2 4WD
Freephone: 0800 487363 Fax: 01923 236879
Email: mailserver@trendm.co.uk
WWW: <http://www.trendm.co.uk>

1998 Published by Trend Machinery and Cutting Tools Ltd. All rights reserved. No part of this publication may be reproduced, stored or transmitted in any form without prior permission. Our policy of continuous improvements means that specifications may change without notice. Trend Machinery and Cutting Tools Ltd cannot be held liable for any material rendered unusable, or for any form of consequential loss.

trend[®]
routing technology



length wise



by Gordon Warr

With formal training as a woodworking craftsman and later as a professional teacher, Gordon is well known to most woodworking enthusiasts through the remarkable number of articles and books he has published.

In the woodworking industry the router has proved itself to be the ideal tool for batch production work. But, it is not only in the professional market that it can lend a hand in saving woodworkers both time and effort.

For the home craftsman or the small craft workshop, the router offers versatility second to no other power tool. Combined with the

vast range of intricately shaped cutters now available, the routing concept requires only a little imagination and innovation to turn a two dimensional profile into a three dimensional object.

Good examples of this method of production on a small scale are my toys by the 'metre'. Toy cars, lorries and trees, as pictured here can all be simply and quickly produced by this method, along with other similar outline designs such as buildings, boats and animals. Each is cut with one or a combination of basic cutter profiles, machining along the length of the timber ready for crosscutting to separate each individual item. A router table is essential for this

Gordon Warr suggests a simple method of producing toys by the metre!

work, both for safety and accuracy. For cutting some of the profiles a router of at least 900 watts will be needed, while the larger radius cutter will require a 1/2 inch shank capacity. You will probably find



that many interesting shapes can be made up using your existing cutters.

Alternatively, refer to the new Trend 1998/9 catalogue to trace out various profiles and make up your own combinations before purchasing your cutters. Remember that having machined the cutter profiles on the

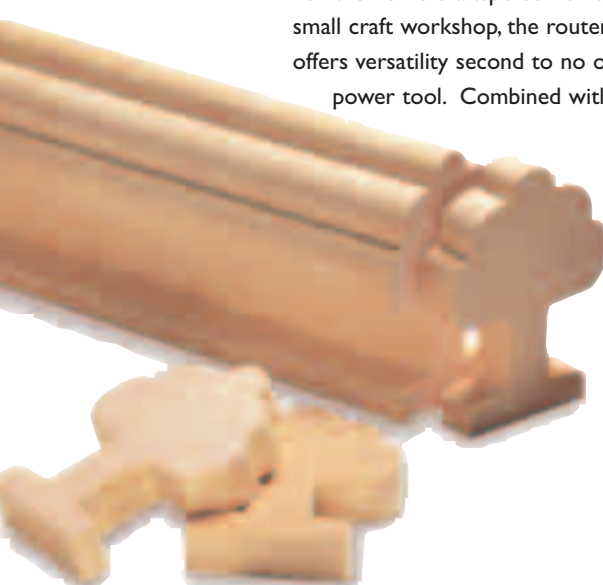

new videos

timber length, a little final shaping to smooth in curves or remove sharp corners can be quickly and easily achieved using simple hand tools. Likewise cutter profiles can be joined or married up smoothly in a similar fashion.

One important point to bear in mind is that the timber should first be prepared by planing it straight and true and that excess waste timber should be removed by cutting rebates and grooves, leaving only the final shaping to be carried out with the selected cutters.

When making cars and lorries, first form rebates along the bottom edges of the strip and cut a groove along the centre of the bottom face leaving two square beads to be machined to the wheel profiles. Large areas of waste such as on the flat back lorry can be sawn on a table saw. The saw table can also be used to cut angled surfaces for house roofs and other wide flat surfaces. Not all the cuts will be able to be made by simply running the square edges of the timber against the router table or fence. It may be necessary to make up support blocks or jigs to be able to present the work to the cutter at different angles or to keep it level while machining.

Another alternative when forming the basic profile is to machine different shaped sections of timber and glue them together in a long length. This can produce attractive finishes when using contrasting timbers. Finishing with

A circular saw or band saw fitted with a fine tooth blade is best for separating the profile sections using the table fence to determine their width. Alternatively use a fine tooth handsaw, taking care to cut the sides square and parallel.

If you keep your cutters well honed (do it regularly on a diamond stone), you will only need to lightly sand the machined surfaces before applying a finish. In order to sand the sides, stick a piece of abrasive paper to a flat surface with double sided tape and rub the faces over it, keeping them flat to the surface.

Always use close grained woods such as Beech. However, for a more decorative effect use combinations of light and dark woods, such as holly, maple, mahogany and cherry, but again avoid woolly or coarse grained varieties. For children's toys, bright coloured stains or varnishes can be applied, but as with all paints and other finishes only use those that are non-toxic and stated to be safe for children. **IP**



The Router - A Beginner's Guide

The editor of The Router Magazine, Alan Goodsell demonstrates the techniques, the tools and the accessories to unleash the full potential of woodworking's most versatile tool.

Ref VIDEO/TRBG

Professional Door Fitting

This video, one of a series featuring Trend jigs and equipment for the router, explains how the Hinge Jig and other unique accessories assist the carpenter to fit doors with maximum ease and efficiency.

Ref TV/5



Affordable CNC Routing

This video demonstrates the range of applications which can be carried out using the CNC860 together with complimentary products such as software, jig-making accessories and tooling.

Ref TV/6

The Trend Routing System

This video looks at the two routers, the T5 and T9, together with the MINIMACH vacuum clamping system and the DJ300 Dovetail Jig. It shows how to use these and other products to accomplish many woodworking tasks.

Ref TV/7



new products

A selection of new products now available from your local Trend stockist



MiniMach

The self-adjusting vacuum clamping bed, powered by any workshop vacuum extractor, that grips itself to the workbench and holds your workpiece solid. Routing, sanding and hand planing are simple and clamp free. The MiniMach holds sheet materials up to 1220mm sq. down to 95mm sq. and includes a hanging bracket for easy storage in your workshop.

Clamp Guide Pro Track

These three new lines in the Clamp Guide range feature a wider aluminium extrusion, with the same integral clamping mechanism but with three tracking attachments. They come in 2, 4 and 8 foot lengths, the 8 foot being ideal for machining larger panel material. The wide 5" aluminium has

T slots for attaching the base plates and end stop. The system therefore provides an accurate and stable means of guiding routers and saws.

Bench Clamp Back to Back

These portable bench clamps provide obstruction free clamping to your work bench or trestle. They not only clamp to the bench but will also securely hold the component for routing and sanding operations.

Router Carver Templates

Three new designs have been added to the Trend range of Router Carver templates, including the Fleur De Lys and the Folklore which has been increased in range. A new Dolphin design can be carved left or right and is ideal for any bathroom or a child's bedroom.



Change it quick...make it

Snappy®

The Quick Release Drill System

The Snappy range is the most effective way to increase productivity for drilling and fixing. Now, 19 new lines make this an essential product for all DIY enthusiasts and tradesman.



Hex Step Reamer - HSS

Specially for use with Snappy Taps fitted into torque controlled screwdrivers. They are designed to drill the pilot hole required for a Snappy tap. Ideal for jig-making. Two sizes are offered (SNAP/SR/1 and SNAP/SR/2).



Hex Tapered Drills - HSS

For drilling and enlarging holes in all metals, plastics (up to 2mm thick, man-made boards and wood up to 6mm thick). Two sizes are offered, 3mm to 7mm (SNAP/TD/1) and 3mm to 14mm (SNAP/TD/2).



Hex Taps - HSS

For use in torque controlled screwdrivers on metals and plastics. Six sizes are offered M3-5, M4, M5, M6, M8 and M10 (SNAP/TAP/M35 etc). A coolant is recommended.



Hex Magnetic Screwdriver Bit Set

The SNAP/SB1/SET comprises a magnetic holder and 6 assorted screwdriver bits in a plastic case/holder. These Pozi® bits feature a unique torsion zone to minimise the possibility of breakage.



Hex Countersink

The SNAP/CSK/1 is an 82° countersinking cutter for wood and man-made boards and is made from tool steel.



Hex Plug Cutters

For cutting plugs in wood. Two sizes: 3/8" (9.5mm) and 1/2" (12.7mm) to suit the Snappy range of Hex Drill Countersinks (SNAP/PC/38 and SNAP/PC/12).

Metric Drill Bit Set

Our seven piece Hex Drill Set is now available in a Metric size, ranging from 1mm to 7mm in diameter (SNAP/SET/2).



Tradesman Sets

These three sets incorporate one of each of the four main lines and are designed for a specific screw size. Each set comprises a Quick Chuck, Drill/Countersink, No2 Pozi® bit and Drill bit guide. These sets suit screw sizes No6, No8 and No10. (SNAP/No6/SET, etc.)



19 Piece Drill Set

This Snappy boxed set with metric hex drills (SNAP/KIT/2) is ideal for the home improvement enthusiast and professional. (Also available in Imperial)



windows for woodworkers

John Harrington reports on the latest generation of affordable CNC routing hardware and Microsoft Windows-based software.

The development of computer numeric controlled (CNC) routing, using affordable personal computers has already begun to revolutionise all aspects of the woodworking industry. In so doing it has created new opportunities for large and small businesses as well as for individual craftsmen.

CNC is a technique whereby the movement of a router head is controlled by instructions from a computer. These instructions come from a computer program or list that the user keys into the CNC 860 console or into a computer as ISO standard commands called 'G' codes. As an example, the code G01 X100Y100, instructs the head to move in a straight line to a point horizontally and vertically 100mm away from its starting position.

The CNC 860

The Trend CNC package is based around the Elu/DeWalt CNC 860 Machining Centre, which has a machining area of 860mm x 860mm x

90mm. These dimensions relate to the three axes, X, Y and Z (width, length and height). Each axis is served by a separate stepper motor, controlling the movement of the routing head. Two head options are offered: a modified portable router or a continuously rated, high cycle motor, that provides improved performance for intensive machining applications.

Programming directly in G-codes through the console can be time consuming. To assist the operator, a PC software application called CNCTalk is included with the machine. This is a basic computer aided design (CAD) application which runs under DOS, the original PC operating system before Windows. It is useful for intermediate applications like cutting out irregular shapes. However, to gain the maximum versatility from the CNC 860, Trend's Open Sign System Software for Windows is the most effective solution.

OSS consists of two separate software applications: OSS Draw



which provides the drawing tools to create any shape or sign, and OSS Work which handles all the routing and tooling-related parameters like depth and offset. Graphical simulations are shown for all tool parameters enabling the user to perfect a design before routing any material.

Sign-writing

As an example of how these products work together, the method of producing a simple sign is shown, incorporating two different lettering styles and a graphical logo.





Having launched OSS Draw, the first step is to draw a box or boarder on the screen to indicate the overall area of the work. This can be either a simple rectangular boarder or a more decorative one.

This border then needs to have a depth assigned to it. This is done by using colours to define the depth of each area.



The logo is then created using the drawing tools within OSS Draw.



The words are keyed in using the text function. Again, colours are assigned to each area to produce a graphical representation of how the finished sign will look.

The next task is to define the routing parameters. In the example, the red

and blue areas of the logo and the lettering have been assigned a depth of 5mm and the green area assigned a depth of zero. The same dialogue box lets you specify whether a letter or object is engraved or routed through the material.

The cutter profile that will be used can now be defined. With lettering, particularly serified fonts, the cutter used needs to have a small diameter, perhaps 3mm. However, to achieve a 5mm cutting depth this will have to be routed in several passes.

A simulation of the cutting path is now drawn on screen. Having then created a G-code file of the sign ready for the CNC 860 to cut, the file is downloaded to the CNC 860.

The design can now be routed, the material being held on the bed by an adaptable clamping mechanism.

From the simulation, the path that the tool will take is known allowing a datum point to be set using the zero key on the console, and the program



is run using the start key. This type of routing operation takes around 20 minutes to complete and requires no further involvement by the machine operator.

Other accessories

Sign-writing is just one of the many complex and wide ranging routing operations that can be carried out using the OSS and CNC 860 package. OSS also has a range of tools for drawing component shapes and profiles directly or with an electronic sketchpad (graphics tablet).

Vacuum Clamping

To reduce the through-put time for this kind of operation, the CNC 860 can also be used with a vacuum bed. Trend offer a complete range of affordable vacuum pumps and jig-making accessories to enable all CNC users to produce a highly automated production system to suit their own specific requirements. **IP**

Below: The high cycle motor offers improved performance and low noise for intensive machining applications.



Left: The finished sign. The CNC 860 can be used to machine natural timbers as well as man made boards and plastics such as this acrylic sheet.



A new video is available - see page 5

routing innovations

Jack Cox explains a few of the unique routing techniques possible when using his Pivot Frame Jig.

A retired electronics engineer, Jack has acquired an enviable reputation for both his medal winning lathework and the intricate decorative work that he produces on his innovative Pivot Frame Jig.



by Jack Cox

The Pivot Frame jig was originally designed to cut circular rebates for fitting small mirrors into frames. However, it has proved to be a highly versatile routing jig, with uses way beyond those originally envisaged. The following examples explain a few of the many applications devised so far - doubtless there will be many more in the future.

Mini-pivot frame jig operations

The Pivot frame jig is used for creating an artificial centre point, allowing the router to be rotated around a circular disc template of MDF or plywood. The radius of the circle and the cutting radius is altered by changing the position of the router along its rods. In this way, the problem of the pivot point disappearing beneath the base of the router is eliminated.

Beam trammel

Conversion to a standard beam trammel mode permits the jig to make its own circular disc template by swinging it about the detachable pivot supplied with the jig.

circular disc template can be used. This smaller disc is drilled to take a central bolt, enabling it to slide along a slot cut through the primary disc or worktop allowing the workpiece to be offset from the pivot point or



The circular disc template can also be drilled with a series of equally spaced holes on its outer rim. These are engaged by a small rod or indexing pin, mounted in a 'stop block'.

Twenty four holes enable a full circle to be accurately divided into combinations of equal segments. Alternatively a smaller secondary

primary disc centre. It can then be rotated in steps, determined by the indexing holes around the rim of the secondary disc. Either of these two methods can be cut to both internal and external scalloped designs.





As the device is inherently accurate, using the jig as a mini-pivot, allows holes and roundels of various diameters to be cut with the same cutters. It is also a simple matter to make routed rings and fit them into matching grooves, separately or in an inter-linked fashion.



For small work, the grooves are machined from scraps of timber to fit into the recesses accurately (some preliminary experimentation will be necessary). For this, each piece must be mounted at the exact centre of the circular disc template leaving a small wafer of timber at the base to retain them, the wafer being removed by sanding later. The rings are then replaced in the recesses to machine the joints required for inter-linking, an important point to note since the joint faces need to be accurately curved.

Finally, it is possible to adapt the pivot frame jig to machine ellipses. Maximum dimensions are limited by the size of the circular disc template but within this constraint any axis ratio (ie. combination of major and minor axis) can be achieved. Details on cutting ellipses and other pivot frame jig projects can be found in my book *Decorative Routing - Jigs and Techniques*. **LP**

By using longer guide rods (500mm) together with the circular disc template the mini-pivot is capable of forming radii up to 175mm.



By using the jig as a ski system, planing operations avoiding the dangers and difficulties of working short, thin or twisted material can be performed. In addition, 'flattening' operations on fairly large pieces of stock and any form of guided work against a template are simple to execute. For edge moulding operations, the jig can be set-up as one-legged ski or support system, ensuring that the router remains level throughout the operation. ▲



The Pivot Frame Jig can also be used in conjunction with the Clamp Guide, to maintain contact between the router and straight edge throughout the routing operation. With the guide clamped to a flat worktop or workpiece and the jig bars set either side of the guide, any deviation from the cut line is eliminated allowing the cutter to be fed into the wood in either direction. This method can be easily used for machining parallel channels and edges and for accurately machined halved/scribed joints and precise mitres. ▲

past & present



In the first issue of INProfile, Jim Phillips explained the origin of today's routers, but what of the cutters and how did the current range originate.



by Jim Phillips



A 'tooth', forerunner of today's router cutter.

In the beginning!

The router cutter of today has a strange origin as it evolved from a primitive tool called a "tooth". It derived its name from the limitation of dentistry at the time when a single projecting tooth was a common sight. The tooth took the form of a ground tapered steel chisel, wedged into a wooden stock and was used for cutting square and radiused grooves. Skilled hands produced clean cut grooves by a series of gouging movements. A metal version was made by Stanley some years later, with built-in adjustments and some craftsmen use versions of this up to quite recently. A picture of an early metal version is shown below.

1870's

In the 1870's however, someone thought that by making the blade rotate simultaneously with the forward motion, something useful would happen. What an understatement! Even before the electric motor entered the equation, cutters were being rotated by the means of a foot pedal. The Barnes Former for instance, ran at 2500 rpm, with the operator having to exert himself to achieve a reasonable degree of cutting ability. This type of routing machine, first produced in the USA in 1872, was reported still to have been in use in the 1930's. This was the forerunner of the spindle moulder and later the router of the post war period. But cutting geometry was in it's infancy and cutting edges blunted quickly, especially when used on abrasive timbers.

Twin bladed Cutter Block

A product used in the 1930's mainly in conjunction with belt driven stationery routers at speeds from 6000 to 8000 RPM. Blades were first cast, then produced in HSS and finally in solid tungsten and known as Widia and Wimet steel. The original steel blades were ground by hand to the required profile but the range of styles were very limited.

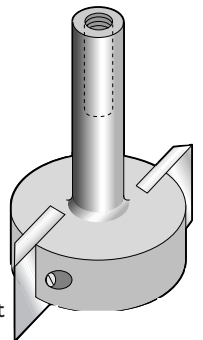

1920's and onwards

In the UK, it was William Day of North London Saw Works who produced the first high quality tooling in 1926. But in 1938 a carbide tip brazed onto a HSS cutter was released with astounding results, the TCT cutter had arrived.



Single Blade Cutter Block

Single bladed blocks were used from the late 1920's right up to the 1950's, especially by pattern makers. These were produced in numerous styles and the advent of cutters with bottom cut geometry was traced to this early design. These tools could be run at greater speeds, smallest diameters at 18,000 RPM and largest at 12,000 RPM.

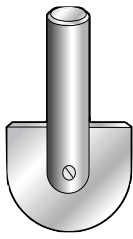

1990's and beyond

Innovative tooling continues to be developed. Examples of this include solid carbide spiral cutters, ROTATIP replaceable tip cutters and PCD tipped tooling. For improved safety, integral chip limiters are now designed into cutters with diameters over 16mm, and restrict the level of injury should a cutter be contacted. **IP**

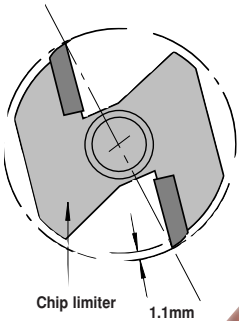

furniture focus 2



by Tom Rogers

Tom Rogers describes a simple way to enhance the appearance of a piece of furniture.

One useful routing accessory that lends itself to this is the Trend Routercarver. Intended for cutting decorative carved motives into panel faces, frame corners or as intricate surrounds for door handles and other furniture fittings, the system uses a number of interchangeable templates, held by a single frame, to produce many varied designs.

Although each Routercarver set uses two or more templates to produce a specific design, for a simplified effect, fewer cuts can be selected from each standard template to achieve a unique carved style of your own.



In my example I have taken a section from the Classical template Ref. RCT/HS/C, to produce a carved frieze along the bottom of an ottoman. The carving on the top of the box is Ref. RCT/LP/C.



To locate the holding frame and templates in position, it has been necessary to temporarily remove the feet and the bottom plinth moulding. A clamping batten is fitted in place of the plinth moulding. Carefully select the section of carving on the template and calculate the spacing between each carved section on each face of the workpiece. Remember to always cut a trial sample first to avoid risking the workpiece.

The Trend Clamp Guide straight edge can be used to position the template frame square to the edge of the workpiece or panel in each cutting position. In this example, I also used it to set a margin and guide the router to cut a decorative line around the ottoman. For this I fitted a radius cutter, although a v-cut or shallow square recess (straight cutter) can be used for these border lines.

Various finishes can be applied to the work, either to match the existing finish, or having stripped and sanded the surface, a new finish to match other furniture or interior style. The surface can be stained and varnished or have a paint or paint effect (ragged, sponged etc.) applied. Alternatively an attractive effect can be achieved by highlighting the carving using a contrasting colour. **IP**





joint winner

The DJ300 Dovetail Jig is a versatile accessory which enables any router user to create traditional dovetail and other joints with a router.

new DJ300 dovetail jig

Dovetail joints are recognised as one of the strongest and most attractive ways to join timber, but cutting a dovetail by hand is difficult and time consuming. The combination of the DJ300 Dovetail jig and a router such as the Trend T5 enables dovetail joints to be produced easily with perfect accuracy, in a fraction of the time.

The jig features a precision engineered design to ensure that the 'tails' and 'pins' are cut with identical pitch angles and spacing. It contains everything needed to start making dovetail joints with your router. The base assembly has workbench fixings and strong clamps for the workpieces. The adjustable metal end-stops ensure a symmetrical joint is achieved every time with any of the templates. The 300 mm wide dovetail template supplied with the jig is precision-machined from solid aluminium, as

opposed to plastic or stamped steel templates used with other jigs. Also included is a TCT dovetail cutter, a guide bush and fixings.

The jig is supplied with a comprehensive manual and a voucher for a free Trend Routing System video, giving a useful introduction to using the DJ300, as well as T series routers and the MINIMACH. Spare parts for the jig are readily available if they are ever needed.

It takes just a few minutes to set-up the jig and the router to begin making your first dovetail joint. If you've never used a dovetail jig before its important to familiarise yourself with the way the timber is aligned in the jig and also the depth of cut to achieve a firm joint. All this is explained fully in the manual. As with any new tool, to become familiar with its characteristics, the best idea is always to make trial

joints first in some scrap material.

Two optional aluminium templates are also available. The 1/4" lapped dovetail template produces small half-blind dovetails, ideal for jewellery boxes, artists cases and other smaller projects. This template is used with a 7.74mm guide bush supplied with the template, and a 6mm solid carbide dovetail cutter supplied separately. The end-stops needed for the different joint off-set are supplied with the jig.

The other optional template is for a 1/2" comb joint. It uses the standard guide bush supplied with the jig and a 12.55 diameter straight cutter available separately. These joints have a square profile instead of the tapered shape of the dovetail. This simple



Standard Dovetail cutter



Additional templates and cutters are available



The timber is positioned tight up against the edge guide to fix the joint off-set. The side of this draw assembly is placed in the front clamp and the front of the drawer is placed in the top clamp.



The position of the template is adjusted using the spanner supplied to set the depth of the dovetail joint.



The dovetail profile is formed using the TCT cutter supplied with the jig. The guide bush fitted to the router, follows the fingers of the template.



Once the router is set up correctly, it will cut both pins and tails in one pass.

shape is strong and attractive for projects such as boxes, cupboard carcasses and larger furniture items. See pages 24 and 25 for a detailed look at comb jointing.

The DJ300 offers a winning combination of accuracy, simplicity and versatility to increase your creative potential for many projects. **IP**



the new router

5

black magic!

Our new router, the T5, is a powerful compact machine, perfect for light and medium duty applications. Could it become the UK's most popular router?



The new Trend T5 router has been designed to be the ideal machine to get started with the craft of routing and to offer versatility and performance for the experienced user. It has a classic ergonomic design, combined with an 850 watt variable speed motor. It is easy to use portably and has power to machine dense hardwoods and man-made materials. The electronic speed control gives a 'soft start' which eliminates an initial 'kick-back' typical of older designs.

The T5 has a spindle lock and hex collet nut to make changing cutters simple and safe. A depth gauge and three-position turret stop allow accurate cutting depths to be set or changed quickly and the 50 mm plunge depth is set using the right grip knob.

In the box

The T5 includes all the essential accessories such as a beam trammel,

20mm guide bush, side fence with micro-adjustment, a dust spout, and both 1/4" and 8 mm diameter collets. The 1/4" collet gives compatibility with hundreds of cutters, while the 8mm collet enables larger cutters such as the Router Carver cutter or panelling cutters to be used. Optional accessories include a fine height adjuster and a metal storage case.

Simplicity

The T5 is supplied with valuable sources of information for new users, experienced craftsmen and building trade professionals. A comprehensive instruction manual explains the essentials of how to set-up and use the machine. In addition, a set of our four colour booklets covers all aspects of routing including using popular cutters, home improvement projects and advanced techniques such as making panel doors. Simply by returning the warranty card, a free copy of our latest video 'The Trend Routing System' will be supplied.

This video explains and demonstrates the T5 router as well as other new products including the DJ300 Dovetail Jig, the MINIMACH and the forthcoming T9 router. The literature and video can also be ordered separately.

The instruction manual contains a full listing of all the T5 spares which are readily available, and the machine is supported by a network of service agents throughout the UK.

Compatibility

On its own, the T5 will perform many routing operations. However, combined with our jigs and accessories it forms the key component of a workshop system to make routing more creative and productive. Jigs such as the



Craftsman Router Table, DJ300 Dovetail Jig, Routerlathe, Pivot Frame Jig and the Routercarver can all be used with the T5 to accomplish many woodworking tasks, without the need for complex hand skills.

Specifications

Plunge stroke _____ 0-50mm
 Power input _____ 850 watts
 Standard collet dia. _____ 1/4" & 8mm
 No load speeds _____ 9,000-27,000 rpm
 Weight _____ 2.7kg (6lbs)
 Voltage range _____ 115 & 240 volts

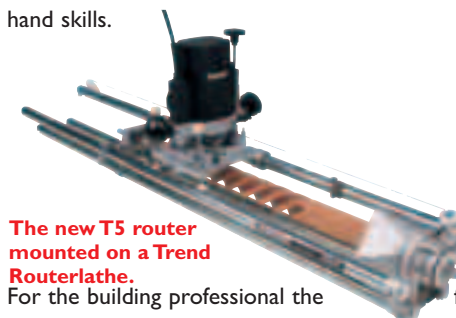

The new T5 router mounted on a Trend Routerlathe.

For the building professional the T5 will also be available soon in a 115 volt version making it ideal for use on site, especially with products such as the Hinge Jig and Routabout.

The T5 is the first of the Trend T series routers. With features and accessories for almost every routing application, it seems destined to become the preferred portable router for craftsmen and professional users. **IP**

Standard Accessories



Edge moulding using the **side fence** as a guide.

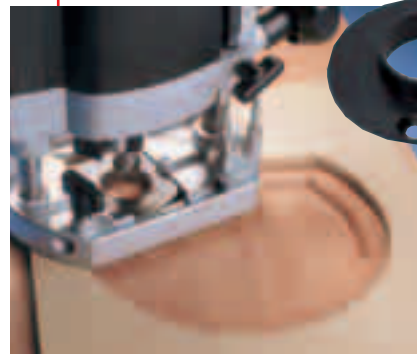
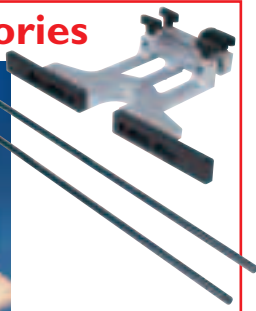

Template routing with the router fitted with the **guide bush** supplied.

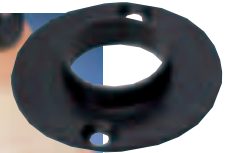

Cutting circles using the **beam trammel** attachment.

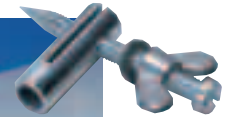

Dust extraction spout for connection to a dust extractor.



Optional Accessories

Fine Height Adjuster
FHA/001



Metal Storage Case
 Divisions and space for cutters and accessories.
CASE/T5





a cut

above the rest

Trends product development manager, Neil McMillan, offers advice on what to look for when buying circular sawblades.



by Neil McMillan

Neil is a qualified wood machinist, who has written many articles on routing.

Using the latest design and production technology, circular sawblades are now available in a wide range of tooth configurations for cutting all natural timbers and wood based products, as well as non ferrous metals, plastics and other materials. Each tooth configuration offers different cutting characteristics to suit various performance requirements, such as fast or slow feed rates, in fine and coarse materials.

It is not only the teeth of a circular sawblade that play a role in its performance, but the saw plate itself needs to be designed and produced to specific criteria to avoid distortion due to flexing and friction when cutting. The combination of both the tooth and plate design must also take into account other factors such as waste material dispersion, heat expansion and noise reduction. Only by taking all these factors and other criteria into account at the design stage, can a circular sawblade be expected to produce an accurate

precise cut and an acceptable standard of finish on the cut surfaces.

The Trend WAVEFORM® range of Tungsten Carbide Tipped sawblades is aimed at the professional user and has been designed for high performance and reliability, while remaining cost effective. The sawblades are available to fit virtually all current ranges of portable, crosscut, radial arm, bench mitre, table and bench saws. Diameters of blades range from 150mm up to 400mm, with tooth forms and teeth numbers to suit most applications required by woodworkers, builders, carpenters, machinists and other craftsmen.

Sawing terms

Rip sawing Cutting along the direction of the wood fibres, with the grain.

Crosscutting Cutting across or at an angle to the wood fibres, across the grain.

Kerf This is the saw cut and therefore equal to the width of the teeth or the overall width of the set of the teeth. Although thinner blades tend to cut faster, they may also bend under excessive side loads, creating a wider or deviating kerf.

Top bevel clearance (a) -

Determines how cleanly the blade cuts and enables gradual penetration into material.

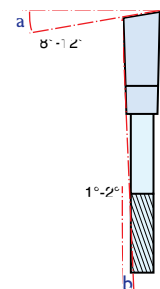

Radial side angle (b) -

Ensures clearance between teeth and kerf side.

Hook or rake angle (c) -

Angle of tilt of the tip.

- Positive (forward) for ripping.
- Negative (backward) for cross cutting.
- Zero for plastics and aluminium.

Top clearance angle (d) -

Ground according to hardness of material to be cut.

Tooth pitch (e) -

Dimension between two teeth and denotes number of teeth. Smaller the pitch, greater the number of teeth.

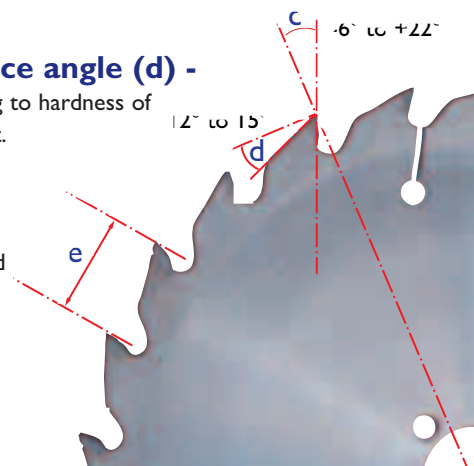

The Saw plate

The saw plate is first precision cut as a flat steel disc from high quality hardened chrome alloy steel of a consistent thickness.

The tooth profile is then machine ground or laser cut around its circumference.

The bores are accurately reamed to ensure precise concentricity and balance.

Microgranular TCT (Tungsten Carbide Tips) are copper brazed into a seating ground in the plate

tooth profile.

The carbide tips are diamond ground to precise tooth forms.

Top quality blades are then hardened, tempered and roller tensioned to ensure that the plate is flat and rigid. Cheaper sawblades are prone to distortion or imbalance in the plate which will cause vibration in use, resulting in a poor surface finish and inaccurate cutting.

T.C.T.

Being an extremely hard material, Tungsten Carbide produces a tooth that has far greater wear resistance

than the plate steel, but can still be ground to a sharp cutting edge. This greater wear resistance allows TCT blades to be used to cut abrasive materials such as resin based particle board (chipboard etc.), melamine and plastic laminate faced materials and aluminium. TCT blades are also suitable for use on all natural timbers, both hard and softwoods and less-abrasive sheet materials.

Tooth Form

The quality of cut or surface finish depends mainly on the tooth form and number of teeth around the blade circumference. Generally, the greater the number of teeth, the better the finish.

Variations in the tooth form are designed to suit different materials, specific operations or to produce the best compromise between cutting speed and quality of the surface finish.

Flat top form teeth are intended for cutting along the grain of the wood. The cutting edges of the teeth, being square to the blade axis, obviates any tendency to be deflected from the line of cut by the grain.



Alternate top bevel (ATB) teeth have the cutting edges on alternate teeth, bevelled at opposing angles. This tooth form produces a slicing cutting action across the wood fibres (grain), leaving a cleaner cut reducing break-out (splch) and chipping along the cut edges.

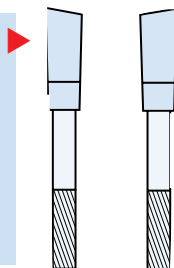

Bore - precision reamed to suit saw spindle

Triple chip (TCP) teeth or (Alternate Trapezoidal) have every other tooth ground flat with the corners of intermediate teeth ground at 45 degrees. These intermediate teeth are also left a fraction higher than the flat tooth. This tooth form is ideal for cutting plastics and non-ferrous metals such as aluminium.

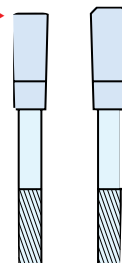

Steel plate - the main body of the sawblade

Gullet - collects and ejects wood chips

Back support - supports the cutting edge

Expansion slot - allow for expansion due to frictional heat build up

Tungsten carbide tips - wear resistant hard metal cutting edge

Cooling slots - found on ripping blades prevent excessive heat build up

Anti-kick back - found on ripping sawblades. The design reduces the amount of bite per tooth and possible kickback

Fitting sawblades:

Check that the spindle flanges or collars are in good condition and clean. Ensure that the blade is the correct type for the job and material and ensure it is the correct size for the machine. Check the direction of rotation of both blade and spindle before fitting. Ensure that the flanges are fitted correctly before tightening the lock nut or bolt, taking care not to cross thread it. If bushing washers are to be used to adjust the bore diameter, check that the flange diameter is greater than the sawblade bore diameter in order that the flanges clamp on the saw plate and not the bushing washer.

Sawblade types & Applications



UNIVERSAL RIP - RP GROUP

For ripping applications on saw benches for cutting along the grain. Chip limiter design for anti-kick back and cooling slots for continuous use. A ripping blade will allow a fast feed rate but will give a coarse finish.

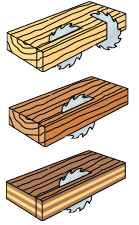
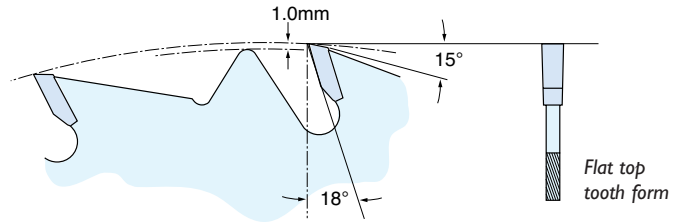

GENERAL PURPOSE - GP GROUP

For general purpose applications and where price is an important factor. These blades will give a medium - coarse finish when ripping.

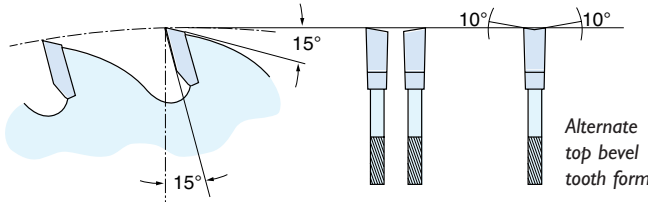
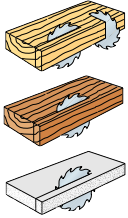

COMBINATION - CM GROUP

For combination applications where cutting along and across the grain is necessary, and where price is also an important factor. These blades will give a medium finish.

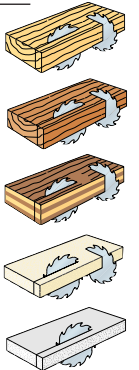
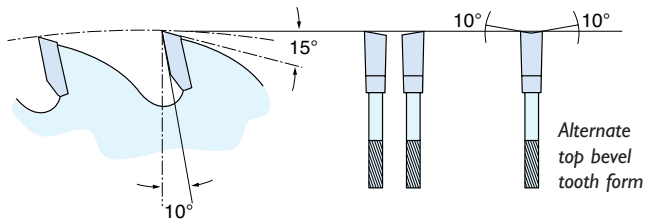

TRIMMING/CROSSCUT - TR GROUP

For trimming or crosscutting applications. These blades will give a medium - fine finish and are particularly suitable for manmade boards.

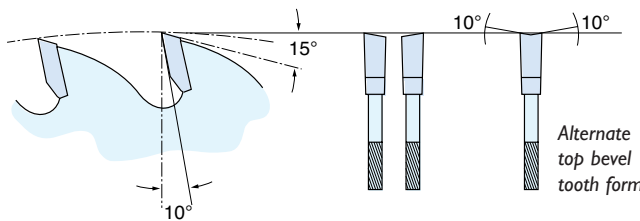
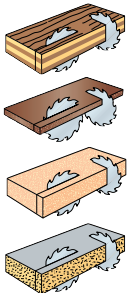

FINE TRIM/FINISHING - FT GROUP

For finishing or fine trimming applications. An extra fine finish is obtained by these blades making them particularly suitable for finishing work. The higher number of teeth results in a slower feed rate.

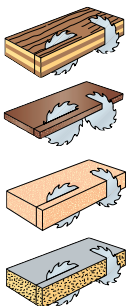
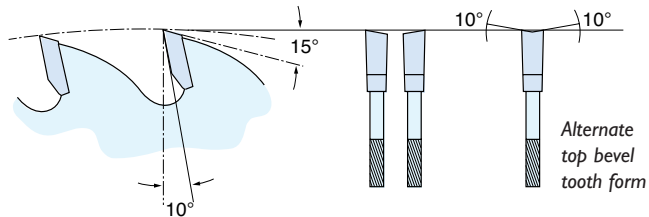

KEY for saw and wood compatibility

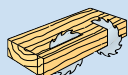

Soft wood rip

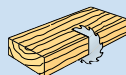

Soft wood crosscut



Hard wood & exotic rip

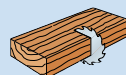

Hard wood & exotic crosscut

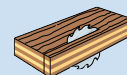

Plywood rip

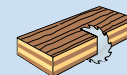

Plywood crosscut

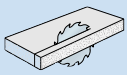

Plasterboard & stone fibre board



PANEL TRIMMING - PT GROUP

For fine super trimming of panels. The high number of teeth and tooth grinding on these blades give a super fine finish in panel materials, especially laminated on two sides. A slow feed speed is required with these blades.

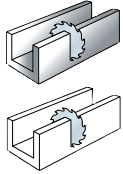
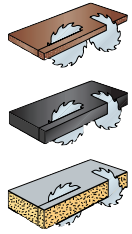
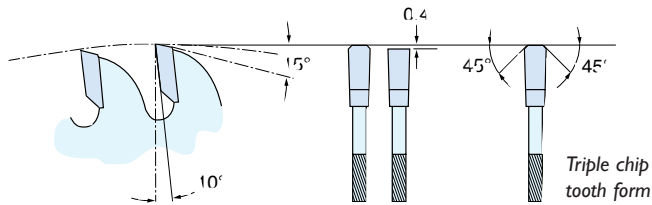

ALUMINIUM/PLASTIC - AP GROUP

The particular grinding on these blades ensure they will give a fine finish in thin walled extrusions of non-ferrous metals or plastics. They have a negative hook angle.

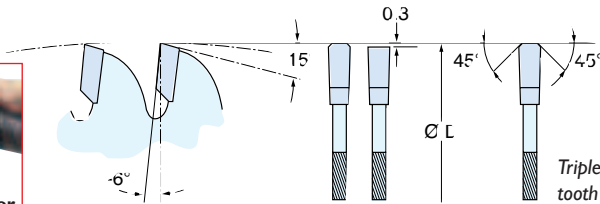

TRENDIWAX®
coolant
recommended for
alloy cutting



RADIAL ARM/MITRE SAW CROSSCUTTING - CC GROUP

The blades in this group have various pitches giving coarse, medium or a fine finish. They are ideal for crosscutting applications in a variety of materials. These blades have zero or negative hook angle to minimise "pick-up" and "snatching".

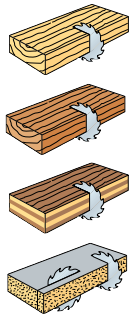
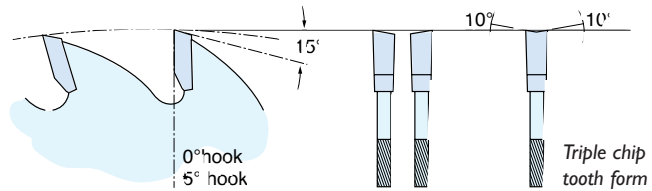

Caring for your sawblades:

Sawblades must be handled with great care to keep them in a good condition and to protect the user. To avoid accidents or damage, they should be left in their packaging prior to fitting to the saw. The sawblades should be carried by a handle or hook fitted through the bore. After removal from the machine, blades should be stored in their original packaging or other protective case or rack.

Cleaning and maintenance

After prolonged use the cutting edges will become dull, this is evident by slowing down of the cut, a poor quality finish and excessive heat build up. Prior to honing (sharpening) the saw blade should be cleaned with a resin solvent such as RESIN CLEANER® to remove residue. A DMT diamond flat file - fine grade can then be used to lightly hone the face of the tips removing only a minimal equal amount from each tooth. For heavier re-sharpening or fine chip removal, TCT sawblades should be sent for professional re-grinding. A dry lubricant spray TRENDICOTE® can then be sprayed onto the blade before use to minimise future resin build-up.

PTFE Dry Lubricant Spray - TRENDICOTE



Diamond Flat File - FFF



Resin Cleaner® - RESIN/100

This newly developed spray-on liquid has resin dissolving properties that quickly and harmlessly remove caked on resin. The liquid also includes a rust inhibiting agent. Sold in a handy 100ml pump-action dispenser.

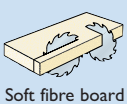

Soft fibre board

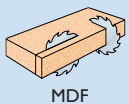

MDF



Hardboard

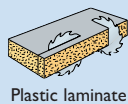

Plastic laminate on one side

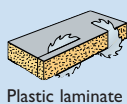

Plastic laminate double sided

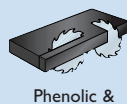

Phenolic & hardplastic

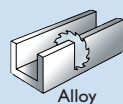

Alloy

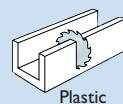

Plastic

comb jointing

Secrets revealed! Comb and Finger Jointing techniques can be mastered. Jeremy Broun tells you how.



Jeremy is a renowned furniture designer and router instructor. He is the author of several books and has produced three videos.

by Jeremy Broun

As well as being simple to cut, the comb joint is a strong and attractive alternative to the dovetail joint for the making up of both small and large carcasses. It is also ideal for other applications such as drawer and box construction where the finger or comb pattern can be used as a decorative feature.

The comb joint is a natural for trinket boxes, musical instrument cases and small tool cabinets using a table mounted router fitted with the Trend comb jointing cutter set. Alternatively, joints for larger work, for example, blanket boxes and chests can be cut using the Trend DJ300 Dovetail jig fitted with the appropriate finger template.

Comb joints can also be cut by using a simple home-made jig and an 8mm two flute straight cutter ref. 3/4 from the Trend range. Gone are the days when the dovetail was considered as the only reliable joint.



The comb joint, sometimes referred to as a finger joint, offers a similar extended glue line and by using a superior modern glue achieves virtually the same strength as a dovetail and can look just as attractive. It is possible to use the joint with good effect in a variety of contrasting timbers and there is scope to use the joint and its jigs and cutters imaginatively.

Using the Trend Comb Joint Set

This cutter set enables comb joints in timber up to 40mm wide (double that if you turn the wood over) to be cut. A heavy duty router mounted in an inverted router table such as the

Trend Craftsman table or Routerack is required. A simple jig is used to hold the workpieces square to the fence while cutting the joint profile. This runs either in the existing sliding bevel fence groove or against the edge of the table, keeping it square to the fence. This jig can be made using MDF and softwood, glued and pinned together.

Preparing the timber

The workpieces (i.e. the uncut sides and ends) must be accurately planed to size, finishing it flat with parallel sides and faces. The timber thickness for this cutter is between 3mm and 9.5mm, matched to the appropriate diameter guide bearing. Maximum material width is 40mm.

It is important that the ends are true square either straight off a dimension saw or a disc sander. Avoid using bowed wood as joint inaccuracy and

When constructing a box, the four sides (A&B) can be cut at the same time. One piece (B) is then turned edge to edge in order to leave flush top and bottom edges when the box is assembled.

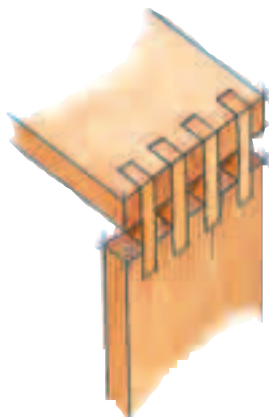
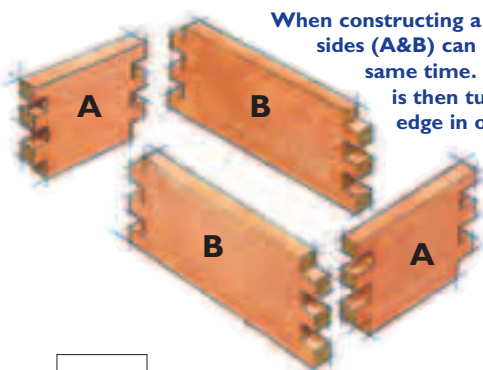

Alternative decorative use of the comb joint profile, separating the members by inserting loose tongues.

Basic finger or comb joint



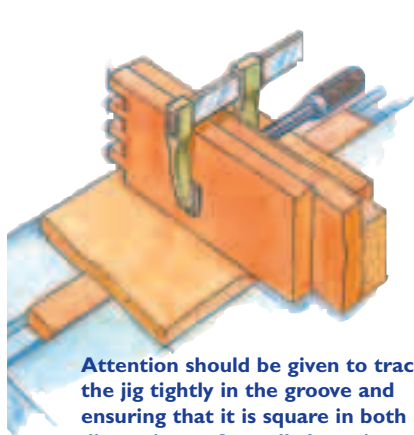

Attention should be given to tracking the jig tightly in the groove and ensuring that it is square in both dimensions. A small clamp is used to secure the workpieces before cutting with a smooth, firm continuous action.

fibre break out is more likely to occur when clamping several members of a box together in the jig for cutting at the same time.

Assembling the cutter

It is easier to set up the cutter assembly with the router mounted in the table. It is helpful to follow the instructions supplied with the cutter set. First the arbor shank is inserted into the 1/2" collet and tightened in

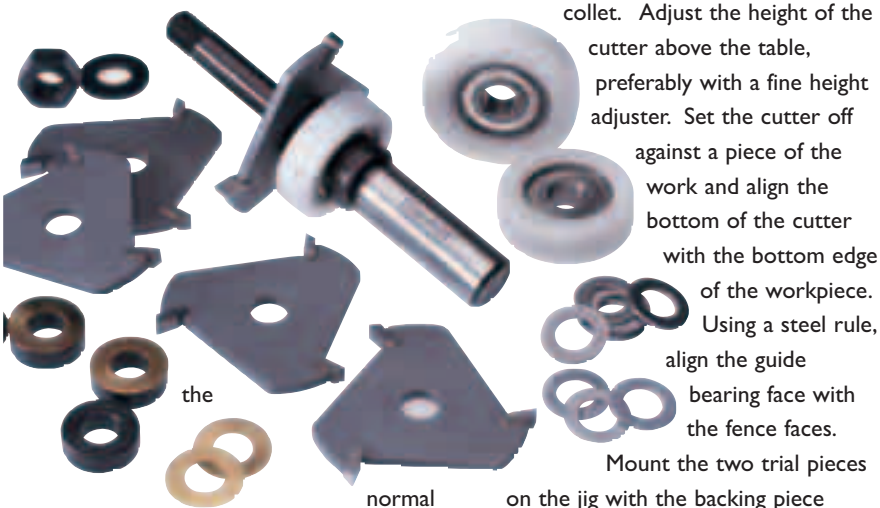

The Comb Joint cutter set comprises five three winged 4mm kerf TCT grooving cutters which are mounted with spacers on an arbor. The spacing between each is precisely the same as the kerf. The cutter assembly is self guiding, one of three interchangeable bearings supplied with the set has been fitted on the arbor to suit the thickness of the timber.

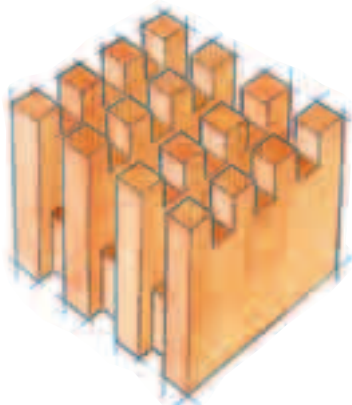

The comb joint profile can also be used to produce interesting and decorative affects for use in furniture and other woodworking projects.

way. The bearing is fitted on the arbor followed by a shim. The cutters are then fitted with a spacer between each. Always stagger the teeth of each cutter to balance and lighten the impact load when cutting. A nut and washer secure the assembly on the arbor, using the routers spindle lock to grip the cutter shank while tightening the nut.

Cutting the comb joint

Prepare the wood to size, checking that the pieces of each pair of sides or ends are equal in length and the ends are square. Remember to prepare extra material for making several trial pieces. To reduce breakout, prepare a backing piece to lie against the face of the sliding jig.

Fit the cutter set into the router collet ensuring that at least three quarters of it's length is held in the collet. Adjust the height of the cutter above the table, preferably with a fine height adjuster. Set the cutter off against a piece of the work and align the bottom of the cutter with the bottom edge of the workpiece. Using a steel rule, align the guide bearing face with the fence faces.

Mount the two trial pieces on the jig with the backing piece against the jig face (clamping them there with a small clamp). Make sure that the locking bar of the clamp will be clear of the cutter path. Check that all adjustments and the

two trial pieces are secured before switching on the router and allowing it to reach full speed.

Grip the jig firmly, keeping fingers away from the cutter and make a pass across the cutter face keeping the trial piece tight to the fence face. Switch off the router after the work has cleared the cutter.

Check the fit of the two pieces, turning one edge over to leave the top and bottom edges flush when interlocked.

Clamp the sides and ends of the box aligning one end of each against the fence face. Cut end profile in one pass before turning the pieces around, aligning the opposite ends against the fence, and cutting those. Remember to fit the backing piece each time and replace it if it becomes ragged.

Dry assemble the jointed box (frame or carcass) to check the joints before cutting the grooves to take the top and bottom. Remember the grooves will appear on both sides or the front and back, unless stopped grooves are cut on the appropriate pieces. These grooves can be cut by setting up the comb joint cutter set with only one of the winged cutters. **IP**





comb jointing

with the **DJ300**

dovetail jig



The Trend DJ300 Dovetail Jig has alternative template options for cutting both dovetails and comb joints. Fitted with the comb joint template, guide bush and 12.55mm straight two flute cutter (Ref 3/76x1/4TC), 12.7mm (1/2 inch) comb joints can be cut in either hard or softwood from 12mm to 20mm thick and up to 300mm wide. The jig is easy to set up and with a little practice, will cut precise and accurate comb joints for boxmaking, cabinet carcassing and furniture.



Timber preparation

Before setting up the jig, each side of the box or carcass must be cut accurately to exact widths in order to produce equal thickness finger and spacing across the width of the workpiece. Each piece must also be trimmed to the exact length required, i.e. equal to the overall length of the box sides. Unlike lapped dovetails where two sides are cut short to allow for the lap, with comb joints the end of the comb fingers appears on each face of adjacent sides.

Check that the ends are trimmed square in both directions. Carefully mark each side of the box (carcass) to denote the face sides and each pair of mating ends to ensure that each piece is cut for assembly in the correct sequence. Remember that the widths of the prepared timber

will be multiples of the pitch of the template fingers.

Backing piece

To avoid cutting into the base of the jig, always use a waste backing piece at least 6mm thicker than the workpiece. As each piece of the joint is cut separately, this is fitted into the jig in place of the horizontal workpiece when cutting dovetails. The backing piece should be of similar width to that of each workpiece (box or carcass side) and be fitted with the forward end flush with the front of the metal jig base. This prevents break out on the back of the workpiece as the joint is cut.



Positioning the workpiece

On the front face of the first workpiece or a trial piece of the same dimensions, draw a centre line along one face. Mark a 2mm offset to the left and the right of it.

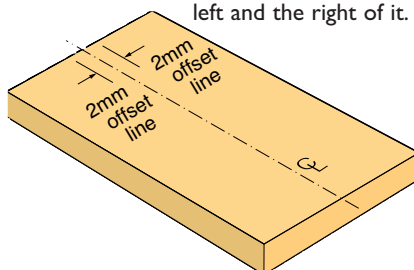

Fit the two edge offset guides but leave them slightly loose. Fit the comb finger template to the jig so that it sits flat and level on the backing piece.

Clamp the marked workpiece to the front of the jig with the top end flush and tight against the underside of the template. Ensure that the template fingers protrude in front of the workpiece and adjust the forward adjustment nuts (fitted to the front clamping bar threaded studs) so that the front of the template is parallel to the face of the vertical workpiece.

For the left hand edge guide, align the 2mm offset line against the left hand edge of one of the template fingers. Tighten the front clamp making sure that the timber does not move. Use a second workpiece to draw a line across the top of the first workpiece to denote the thickness of the mating piece (i.e. the full depth of cut), holding the second workpiece flat and flush beneath the finger template.



Remove the template and slide the left hand edge offset guide against the edge of the timber and tighten the screws. Repeat the setting up operation for the right-hand side edge guide using the right-hand offset line. The offset guides allow each successive workpiece to be quickly positioned without the need to mark the centre and offset line on them.

Setting the depth of cut

With the router disconnected from the power source, fit the guide bush and cutter. Stand the router on the template with the guide bush spigot between two template fingers. Ideally using a fine height adjuster fitted to the router, set the bottom of the cutter fractionally above the horizontal depth of cut line (previously drawn on the face of the workpiece). When cutting hard or abrasive timbers it is advisable to cut to the full depth of the comb finger in a series of steps not exceeding 3mm. After cutting the joint, the cutter can

be lowered to the line for a final trimming cut, or slightly below it to allow for finishing.

Cutting the Joint

Connect the router and switch on. Cut between each pair of fingers, working from left to right. Repeat the cutting operation on each end of each box side. To ensure correctly fitting and mirrored joint is obtained both left-hand and right-hand edge guides should be used.

Checking the fit

Assemble the joints dry to check the fit before cutting the grooves for the top and bottom of the box or cabinet carcass. Remember that the grooves to take the base and top panels (i.e. thin plywood base and/or rebated thicker panel), will show on the face of the box on two sides unless they are cut as stopped grooves.

Using a home made jig

A simple home-made jig can be easily made from MDF and softwood off-cuts. This can be used with any size router fitted with a suitable guide bush (for example a 16mm guide bush and a 6mm diameter two flute cutter).

The fixed batten shown on the underside of the jig matches the comb joint width precisely, in order to space out the fingers on each subsequent pass. A slot in the jig allows the guide bush to track precisely in order to cut each slot in turn.

Secure both pieces of wood plus a backing piece in the jig (the offset must match the cutter diameter exactly). Set up the router with the guide bush and straight cutter and cut the first finger.

Insert the template batten into the first slot and machine the second. Repeat this procedure for each subsequent pass until all the fingers have been cut. Check the joint before turning them over (end to end - otherwise the top and bottom edges won't align flush). **TP**

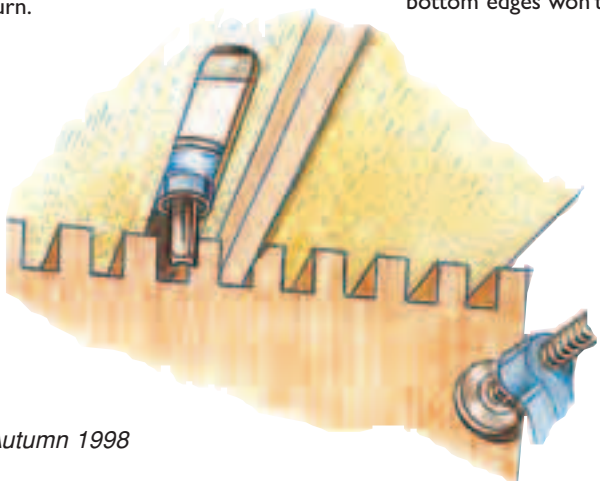
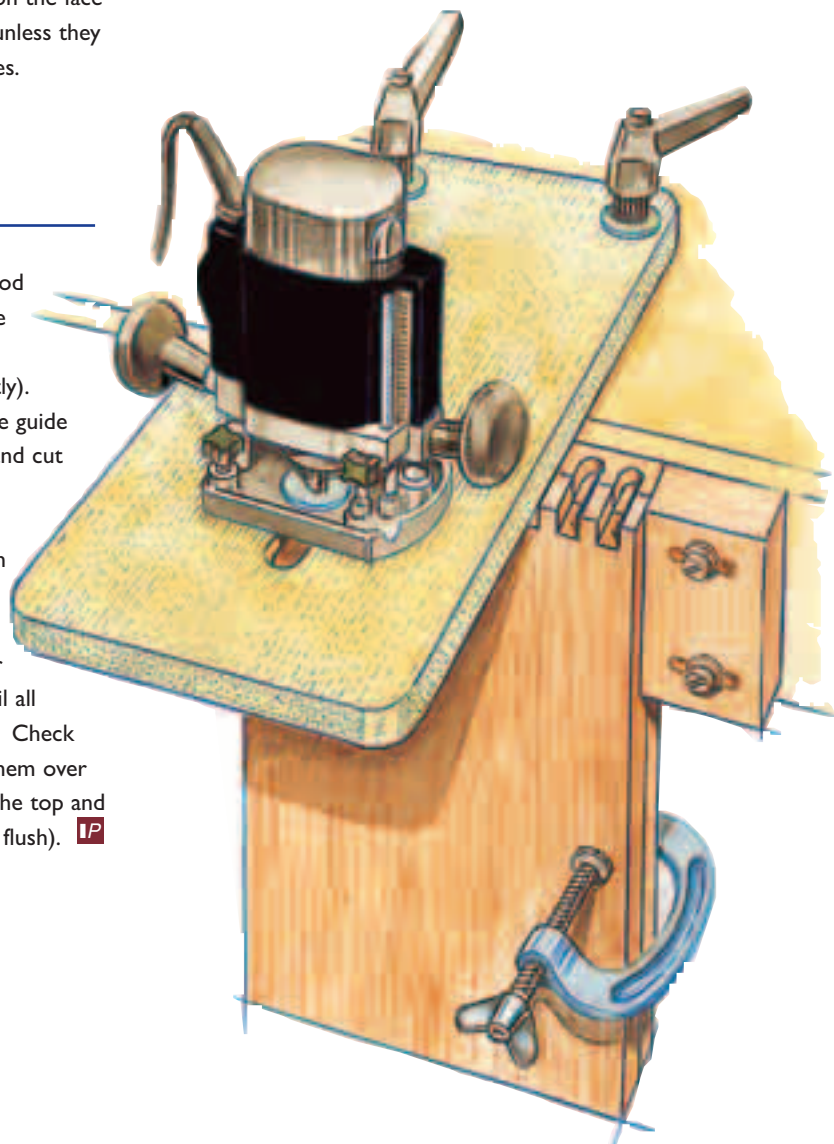

routing *workshop*

under *and* over



by John Perkins

John Perkins adds an additional feature, in the form of an inverted router table, to his dedicated routing bench.

An inverted or overhead table is one of the most important accessories for the router, offering far greater scope in handling material, as well as giving the full range of router cutters. It is also by far easier and safer to carry out many routing operations with the router rigidly mounted and by feeding the material into the cutter, against a fence and on a flat table. Also, as the table, cutter and fence will always remain square to each other, accuracy can be assured.

In our first issue of *INProfile* (Issue 1 Winter 1997 pages 22-25) we featured a dedicated routing bench, that could be easily made in the workshop and that would form a routing centre to support a wide range of routing operations. In this issue we suggest ways of incorporating both inverted and overhead routing facilities in the same routing centre.

One of the many benefits afforded by making your own routing bench, is that it can be of a size to suit both one's own requirements and the available floor

space.

Inverted routing

When making any routing jig or table it is important to keep it simple, both in its construction and its use. For simplicity and reliability, it is worth considering using proprietary products such as those from the Trend range of jig-making accessories. These include mounting plates, threaded inserts, lever handles and knobs, and items from their Routerack Range. A bonus is that the Routerack universal stand set offers many possibilities for mounting the router over the bench.

Mounting the router

One of the main problems in constructing any routing table is in the method of attaching the router, to both ensure that it is secure and rigid and to minimise the loss in the depth of cut due to the thickness of the mounting plate.

Mounting plates

There are various methods of making mounting plates, although it is often better to buy ready drilled plates such as the CRT insert plate. This is available pre-drilled to suit most popular routers.

For ease of fitting and cutter changing, the table aperture should ideally be large enough to allow the router to pass through.



Plates can be made from various materials such as polycarbonate sheet, aluminium or solid plastic. Here the Trend CRT plate is set into a thicker table plate to allow the router to be lifted through the table.

Bench cut-out

On 6mm MDF or plywood, mark out a rectangle equal in size to the mounting plate. Draw a line 12mm from the edges of the rectangle and cut out to form a template. Position this template on the bench centring it across the top and square to the front edge. With a jigsaw cut out the central portion leaving a 1.5mm gap to the inside line. Use a bearing guided straight flute cutter to trim the edge, whilst following the template and a 12mm bearing rebate cutter to form a rebate around the cut-out equal in depth to the thickness of the plate. Check that the plate fits, trimming the edge of the rebate to form a sliding fit with no side movement.

Fit the router plate and check that it is level with the bench surface. If preferred, cut the rebate slightly deeper and either apply metal or plastic shims to the rebate face, or use adjustable screws as supplied in

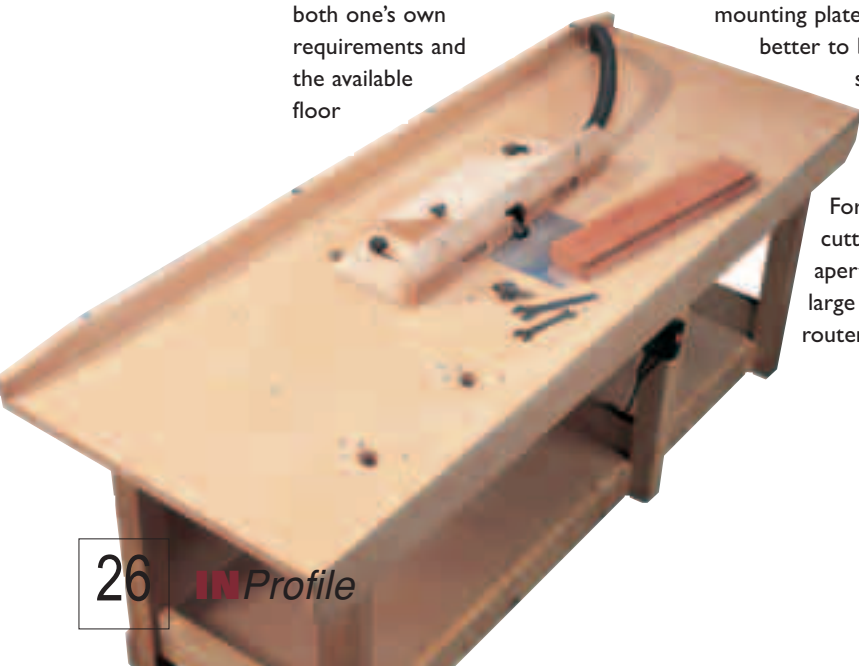



Illustration showing self-made plate for inserting in rebated slot in table.



A simple fence can be made from plywood and fitted with adjustable faces.

the Trend Levelling Kit.

Overhead routing

Most makes and models of routers can be mounted above the bench using the Trend Routerack universal stand. To support the stand pillar, drill a 40mm hole through the bench top approximately 120mm from the rear edge. Turn the bench top over and mark the position of the pillar base mounting holes around it. Drill the holes to take M10 bolts, recessing the heads flush into the top face. Bolt the pillar base to the underside of the bench top.

Follow the mounting instructions for mounting the router on the pillar, either using the clamping bracket assembly, or a tool plate for routers with 43mm or 60mm mounting

collars (ref. RR21 & R22).

Back fence

A simple back fence can be made from Medium Density Fibreboard (MDF) or plywood. This must be designed to cover the back of the cutter or incorporate a cutter guard.

Two slots are cut in the baseboard to allow the fence to be aligned with the cutter using adjustable levers fitted with large washers screwed into captive threaded Teenuts (PTN10/10).

It is advisable to fit a dust extraction port to the fence for connection to a vacuum extractor. In use, the router plate is held down by the back fence. **IP**

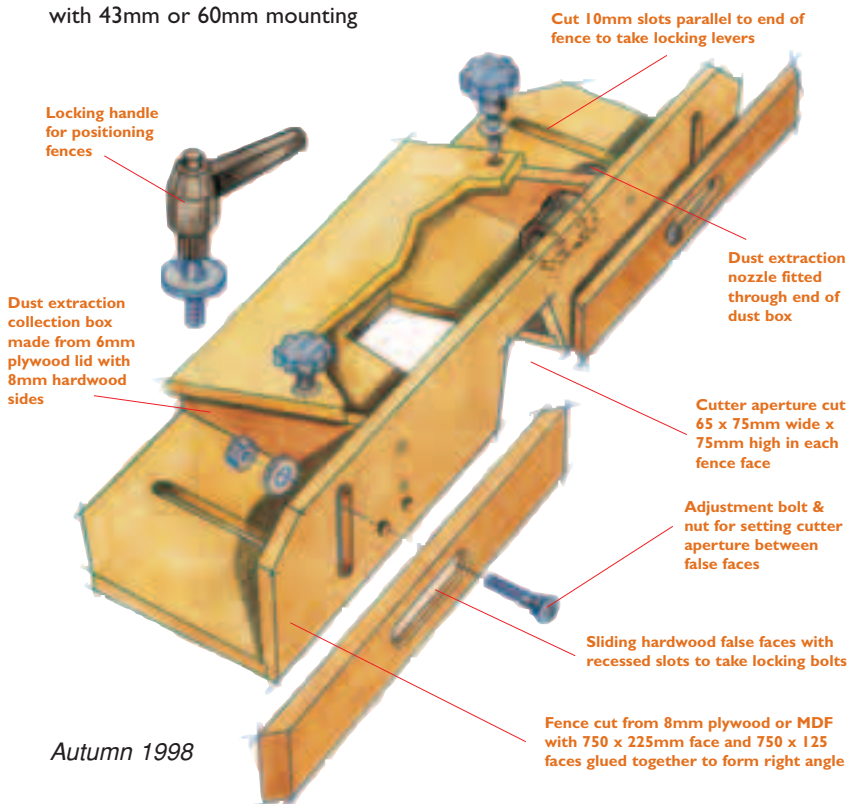

Cut 10mm slots parallel to end of fence to take locking levers

Locking handle for positioning fences

Dust extraction collection box made from 6mm plywood lid with 8mm hardwood sides

Dust extraction nozzle fitted through end of dust box

Cutter aperture cut 65 x 75mm wide x 75mm high in each fence face

Adjustment bolt & nut for setting cutter aperture between false faces

Sliding hardwood false faces with recessed slots to take locking bolts

Fence cut from 8mm plywood or MDF with 750 x 225mm face and 750 x 125 faces glued together to form right angle

Autumn 1998

dovetail competition

Please send in any unusual examples of work made with a Dovetail Jig. We shall feature the best samples in the next issue of **INProfile**. Trend products to the value of **£100** will be awarded for the most innovative design.

Send all entries to:
Dovetail Designs
Trend
FREEPOST
Penfold Works
Imperial Way
Watford WD2 4WD



All entries will be returned. Good photographs and transparencies will be accepted. Closing date 11th January 1999.

routerlathe competition winner

In our first edition of **INProfile** we offered a prize of Trend products to the value of £100 for the best and most innovative examples of work turned on our Routerlathe.

John Pike from Winchester in Hampshire sent in this attractive octagonal planter stand with ornate spiral carving, cove fluting and radial rings.

John used a contour template to create a tapered column in conjunction with the spiralling facility of the Routerlathe, resulting in an interesting irregular flute profile and attractive hand carved texture.

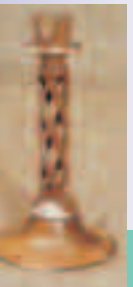
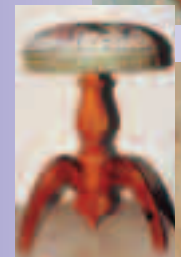

Some more samples are shown here to illustrate the high standard of entries sent. The first two pieces are made by: Bruce Boulter and the last two pieces made by M Baggs.

which direction?

Of all the queries that the Trend technical support receive during the course of the year, the most common relate to confusion over the correct feed direction when using both hand-held or table mounted routers.

One of the most important rules of routing is feed direction. This refers to the direction in which the workpiece is fed across the face of the cutter, or the cutter across the workpiece in relation to the rotation of the cutter. The golden rule is that for all routing operations the feed direction should oppose the rotational direction of the cutter.

What is important to remember is that when the router is above the cutter, shank pointing upwards, the cutter is rotating clockwise when viewed from above (see A). When the motor is beneath the cutter with the cutter shank pointing downwards, the rotational direction of the cutter is anti-clockwise when viewed from above (see B).

Hand-held routing

When using the router as a hand held machine for edge rebating, planing or moulding, the rotational

direction of the cutter is used to pull the cutter into the timber. This ensures that the fence is also pulled into the edge of the material. If fed in the opposite direction, the fence will tend to wander away from the edge leaving an irregular width moulding and making it more difficult to maintain a smooth and even feed speed. Also, there is the risk of the router running away from you creating a safety hazard.

Overhead Routing

When using an overhead router, the feed direction should always be from left to right. Again the rotational direction of the cutter will pull the workpiece against the fence face. Feeding in the opposite direction will create an unsafe and unworkable situation as before. **IP**

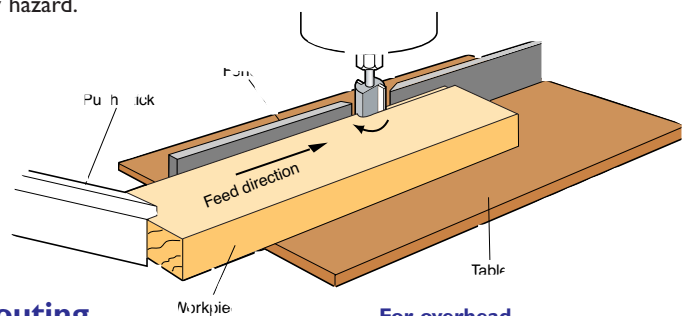

For overhead routing, feed left to right.

Inverted routing

When routing on a table, that is with the router mounted beneath it, the feed direction is always from right to left (against the face of the fence). This ensures that the workpiece is pushed by the cutter against the table fence. If you attempt to feed from the opposite end, the workpiece will be pulled away from you. Not only will you not be able to machine the work successfully but you are likely to be set off balance, again setting up a safety hazard.

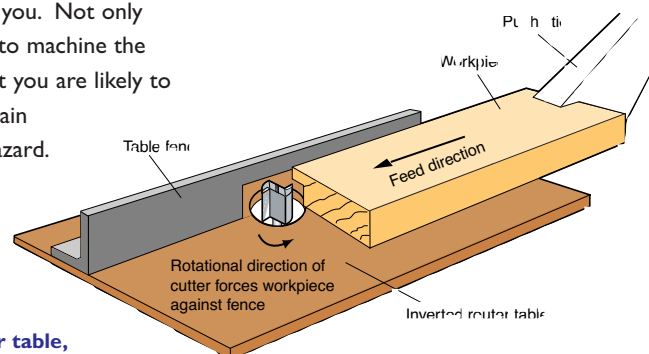

For router table, feed material right to left.

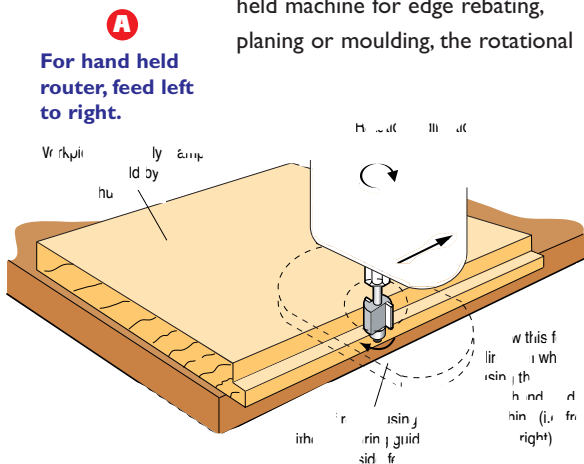

A
For hand held router, feed left to right.

on-site 2

techniques for the trade



A simple jig for mortise Locks

by Miles Davey

Jig making is an essential part of routing and for repetitive operations offers savings on both time and productivity. One example of this is shown by making a simple jig for cutting a lock mortise and the shallow recess to take the lock face plate.

When fitting a number of locks of the same type and size, the jig can be fairly simple. However, a more sophisticated jig can be designed to accommodate different lock and door sizes.

The Trend mortising cutter (Ref. 5/52) is ideal, having a plunge cutting depth of almost 70mm and good chip clearance characteristics to remove waste material quickly. If a deeper mortise is required, a chisel or drill bit can be used to increase the depth.

The template face is secured to the jig cheeks using machine screws and threaded inserts. The recessed slots are cut parallel to the top and bottom and allow the cheeks to be set to suit any door thickness. The length of the slots together with the notched sides of the template face give sufficient clearance for the router base when routing the key slot and spindle hole.



The cheeks have apertures to accept the same diameter guide bush to rout the key slot and spindle holes on either door face. The jig cheeks are wide enough to support the router for this purpose.



Generally a mortise lock body is around 19mm thick, with a face plate width of 25mm.

Please note: Before cutting the mortise and face plate recess, work out the margin between the outside diameter of the guide bush and the outside diameter of the cutter. Margin Formula = Deduct diameter of cutter from outside diameter of guide bush and divide by 2.

A 38mm x 134mm slot is required. This will enable the face plate to be routed with a 1/2" cutter and a 26mm guide bush. By inserting two packing pieces, one at each end of the slot, a 32mm guide bush can also be used to rout the mortise.

Routing the Mortises

Centre the jig across the door edge and secure it using Gripper clamps.

Insert the packing pieces into each end of the slot, and with the larger guide bush fitted, rout the mortise first. Cut in a series of shallow steps, re-setting the depth of cut for each.

Cut to the full depth of the lock body plus extra depth to allow for the recess for the face plate. Then remove the packing pieces, fit the smaller diameter guide bush and cut the shallow face

plate recess. Carefully square the corners of the mortise and recess using a sharp chisel.

Still using the same combination of cutter and guide bush rout the hole for the handle spindle and the slot for the keyhole.

Materials for making the jig

Template Face	1 x 1/2" x 350 x 190mm MDF
Cheeks	2 x 18 x 350 x 210mm MDF
Machine screws	4 x M6 x 16mm panhead
Threaded inserts	4 x M6 for wood





the rout way to do it!

INProfile sent Trend Technical Team member Tom Rogers along to Craft Supplies to review the two day routing course.

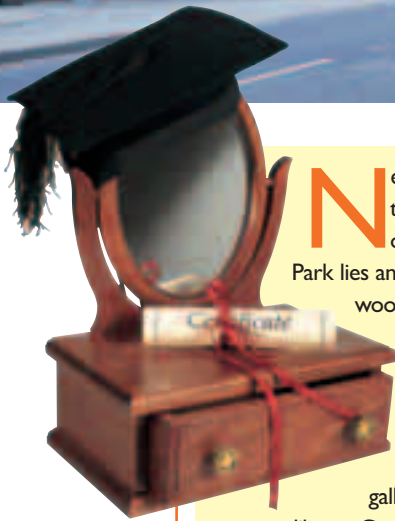

Dressing table top drawer and mirror made on the Craft Supplies course

Nestling amidst the tranquil surroundings of the Peak National Park lies an oasis for woodworkers in the shape of Craft Supplies. Already boasting a well stocked showroom, craft gallery and reference library, Craft Supplies provide several courses including furniture making, lathe turning and routing at the 'Academy' located on site. To assist with this case study I went on their two day routing course.

I arrived at Milne House, (residential accommodation) Millers Dale, the evening before and soon became acquainted with others on the course all of whom had different careers and backgrounds yet shared an interest in wanting to learn about the art of

routing. Our first day started with a hearty breakfast before making our way next door to the 'Academy' where we were greeted by our lecturer Bob Lambert whose career of furniture making and joinery compliments his ability and expertise in routing. Initially Bob dealt with all the safety issues, router features,



Forming the mirror frame with the Mini Ellipse Jig

the importance of router, collet and cutter care and types of cutters. His progression was dictated by the understanding and confidence of his students and led to table routing, hand-held routing and the advantages of jigs and templates.

Craft Supplies have cleverly chosen the production of a dressing table mirror and drawer assembly as their project for the course, incorporating as many basic and advanced routing techniques as the project will allow. By the end of the first day we had planed the edges of our material, and produced our drawer and housing consolidating the Craftsman Router Table and the Dovetail Jig.

At the end of a productive and enjoyable day we spent a pleasant evening in the local public house 'The Anglers Rest'.

The second day introduced rebating and the Mini Ellipse Jig with which we



Completed mirror frame

produced the oval mirror. By lunchtime our project was complete leaving the remainder of the day for the lecturer to concentrate on the particular needs of the students and/or their weaknesses demonstrating the extensive use of the Craftsman Router Table, the Clamp Guide and the Routerlathe.

This is a thorough course which offers plenty of hands-on routing and professional tuition. It is good value for money and provides excellent food and accommodation...highly recommended!



Producing housings for drawer frame

Assembling the dovetailed drawer



Assembling mirror frame brackets

COURSE DETAILS:

Two day basic course available. Course includes table, Dovetail Jig and Ellipse Jig techniques.

COURSE PRICE:

Two Day Basic _____ **£150**

The Mill, Millers Dale, Nr Buxton, Derbyshire SK17 8SN Tel: 01298 871636 **Contact:** Eve Middleton **Lecturer:** Bob Lambert

routing courses

A guide to our sponsored routing courses in the UK



NORTHERN CRAFTS & POWER TOOL CO.

214 Waterloo Road, Blackpool, Lancs, FY4 3AB
Tel: 01253 400066 Contact: Alan Goodwin

Course Details:

Two day basic course and two day advanced course available. Project based - produces table as shown

Course Prices:

Two Day Basic _____ **£150**
Two Day Advanced _____ **£150**

FREE £25 voucher
for all course students
Redeemable towards
the cost of any products sold by
Northern Craft & Power Tool Co. Ltd



EDINBURGH'S TELFORD COLLEGE

Crewe Toll, Edinburgh, EH4 2NZ Tel: 0131 332 2491 Ext. 2229
Contacts: Stuart Telford/Derek Brown

Course Details:

Three one day courses available: basic - intermediate, advanced and trade. Course includes table routing,

Routerlathe techniques and using both Postform Worktop and Hinge jigs.

Course Price:

One Day _____ **£75**



AUSTIN EAMES

Plas Acton Precinct, Pandy Lane, Wrexham, Clwyd, LL11 2UB
Tel: 01978 261095 Contacts: Peter or Richard Eames

Course Details:

Two day basic - intermediate course available. Course includes safety, router and cutter maintenance and techniques.

Course Price:

Two Day Basic _____ **£65**



JOE GREENERS HIREPLACE

Valley Street North, Darlington, Co. Durham, DL1 1PZ Tel: Freephone 0800 7312145
Contacts: Joe or Andy Greener

Course Details:

One day basic - intermediate course and two day advanced course available. Course includes table and Routerlathe techniques.

Course Price:

One Day Basic _____ **£75**
Two Day Advanced _____ **£150**

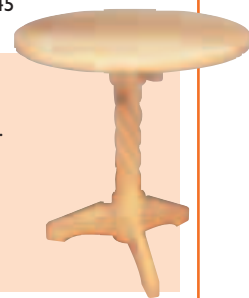

NEATH COLLEGE

Dwr-y-felin Road, Neath, Wales
Tel: 01639 634271
Contacts: Dylan Wyn James/Wyn Pritchard

Course Details:

One day basic - intermediate course and two day advanced courses available. Course includes table, Routerlathe and Carver techniques.

Course Prices:

One Day Basic _____ **£65**
Two Day Advanced _____ **£130**



WOODCRAFT TRAINING

50 West Street, Isleham, Nr Ely, Cambridgeshire CB7 5SB
Tel: 01638 780978
Contact: Mike Humphrey

Course Details:

One day basic - intermediate and one day advanced course available. Course includes hand-held techniques, table routing and jig and template work.

Course Price:

One Day Basic _____ **£70**
One Day Advanced _____ **£70**

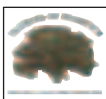

YANDLES WOODWORKING CENTRE

Hurst Works, Martock, Somerset TA12 6JU
Tel: 01935 822207
Contacts: Beverley Mansfield/Ann Pain

Course Details:

One day basic - intermediate course and one day advanced courses available. Course includes hand-held techniques and table routing.

Course Prices:

One Day Basic _____ **£55**
One Day Advanced _____ **£55**



OAKLANDS COLLEGE School of Construction

St Peters Road, St Albans, Herts AL1 3RX
Tel: 01727 737213
Contact: Jeanne O'Reilly

Course Details:

One day basic - intermediate and two day advanced courses available. Courses include table routing, carving and producing panel doors.

Course Prices:

One Day Basic _____ **£81**
Two Day Advanced _____ **£148**



ROY SUTTON'S Routing Courses at the Apple Craft Centre

Selling Road, Macknade, Faversham, Kent ME13 8XF Tel: 01227 373297
Contacts: Roy Sutton/John Farrington

Course Details:

One day basic - intermediate course available. Course includes hand-held techniques and table routing.

Course Prices:

One Day Basic _____ **£60**



new cutters

Cutter Set SS7

Developed from the highly successful SS3 set, this affordable set contains six popular 1/4" shank cutters, comprising a 6mm and 12mm straight two flute, a 90° v-groove, two ball-bearing guided ovolo round overs, (R6.35mm and R9.5mm) and one bearing guided ogee cutter.

Octacut® Eight in One Set

These new sets have been designed to cut eight different profiles: four ovolo, two rounding overs, one cove mould and one rule joint. Three sizes are offered with radii of 6.3mm (25/3x8mmTC), 9.5mm (25/5x8mmTC) and 12.7mm (25/7x1/2TC).



Dished Mould Radius

The 18/15x1/4TC dished mould is an ideal panelling cutter for kitchen or cabinet doors, and for ribbon twist on the router lathe. It has a radius of 26mm and a diameter of 32mm.

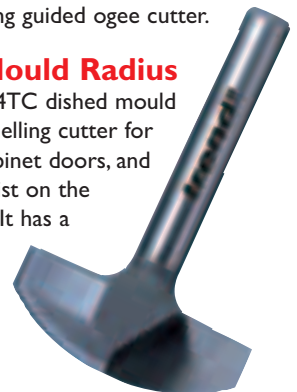

Ovolo Panel Moulder

A new size introduced to complete the range of ovolo cutters. The 7/10x1/4TC can be used for panel cutting of drawer fronts as well as edging window frames, glazing bars, cabinets, table-tops, shelves and fire surrounds. It has a radius of 4mm with a diameter of 19mm.



Straight Two Flute

The C153x1/2TC is a new long reach 1/2" diameter straight cutter added to the Craft Range. It has a cut length of 50mm and can be used with Trend's Postform Worktop Jigs to cut, butt and scribe joints.



90° Guided Trimmer

With a 9.5mm diameter and a 25mm cut length, the 90° Trimmer T46/02x1/4TC is a useful size trimming cutter for laminate and template trimming operations.

Panel & Veining

A range of three 1/4" shank small sized panelling cutters which are also ideal for veining and fluting applications. They are ideal for use with the Routerlathe. The 16/2 has a radius of 4.8mm and the 16/3 and 16/4 have a radius of 6mm and 7.5mm respectively.

Easyset® - Profile Scribers

These Profile Scribers use the same components as our standard PSC sets. Both parts of the joint are cut by only changing the cutter height with no re-assembly of parts required.

The three 1/2" shank styles offered are ogee - (PSC/101), flat classic - (PSC/103) and bevel - (PSC/105). The ogee set is also available in the craft range with an 8mm shank (C155).

