

ROUTING

A guide to
getting started

2

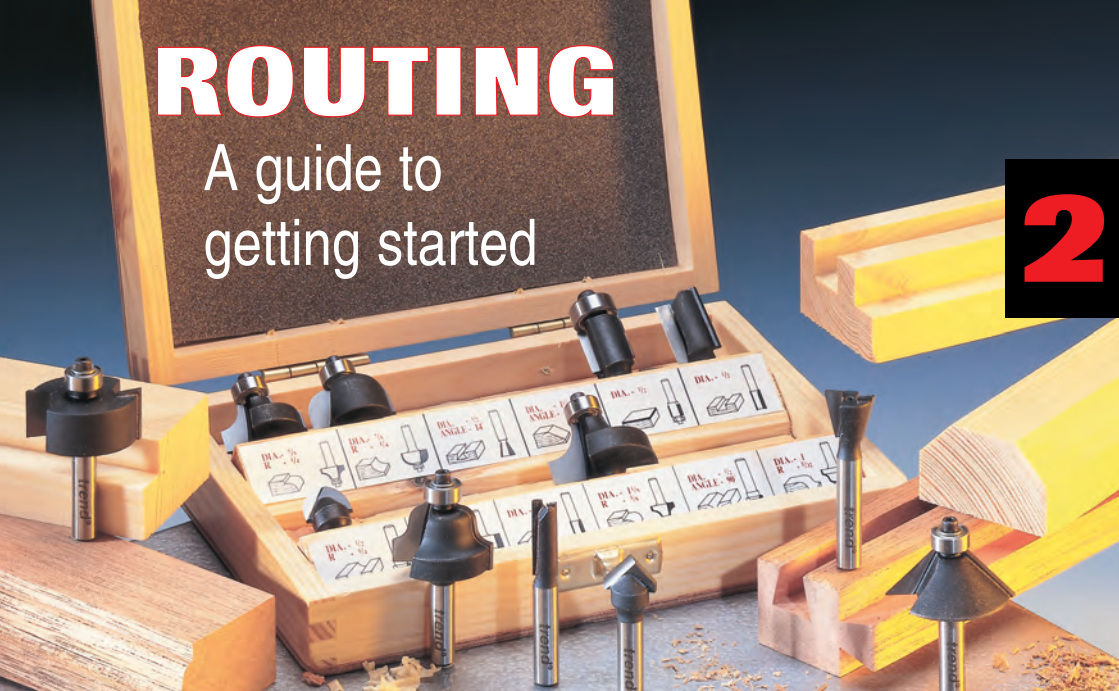

A guide to setting up and using your router and cutters.

CONTENTS

1 HEALTH AND SAFETY _____ 3-5

2 ROUTING BASICS _____ 6-13

The plunge router _____	6
Standard accessories _____	8
Router cutters _____	9
Fitting cutters _____	10
Cutter types _____	11
Safe routing procedure _____	12
Holding the work _____	13

3 GUIDING THE ROUTER _____ 14-23

Freehand routing _____	15
Using the side-fence _____	16
Using batten guides _____	18
Stub mortise & tenon joints _____	19
Using bearing guided cutters _____	20
Using the beam trammel _____	21
Using guide bushes and templates _____	22

4 SETTING THE DEPTH OF CUT _____ 24-25

5 CUTTER SELECTION _____ 26-33

Straight cutters _____	26
Rebate cutter _____	28
Ogee moulding cutter _____	29
Rounding over cutters _____	29
Cove cutters _____	30
Dovetail cutter _____	31
Chamfer cutter _____	32
V cutter _____	32
Trimming and template profiling cutter _____	33

6 CUTTER AND COLLET MAINTENANCE _____ 34

1 HEALTH AND SAFETY

Although routers, as with all power tools, can be dangerous if mishandled, by following these basic safety instructions you will help ensure your own health and safety and protect the well-being of those around you.

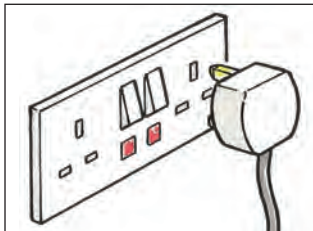

The router:

A Always switch off the router and isolate from the mains supply when changing cutters or making adjustments to the router.

B Remove loose items such as locking bars and socket hex keys from the router and adjacent working surfaces.

C Before re-connecting to the mains supply, make sure the power switch is in the 'off' position.

D Ensure that the power cable is kept well away from the cutter and cannot tangle or catch on the workpiece, jig or fittings.

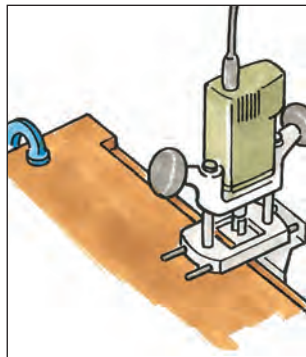
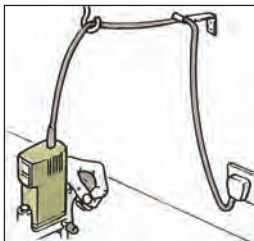

E Check before starting to cut that clamps will not obstruct the path of the router. When cutting through the full thickness of the material, ensure that the cutter cannot foul the vice, bench edge or other obstacles beneath the workpiece.

HEALTH AND SAFETY - CONTINUED



I Keep fingers clear of the cutter and never try to slow or stop the cutter by hand.

J Always keep other people away from the work area to avoid being startled by sudden interruptions.

K Practice the procedure first before starting to cut and concentrate carefully on what you are doing throughout the operation.

The operator:

F Always wear eye protection such as goggles or a full face visor.

G Always wear ear defenders if routing for a lengthy period.

H Do not allow objects to dangle over the work area, i.e. do not wear loose clothing such as a tie. Roll sleeves back and ensure long hair is tied back.

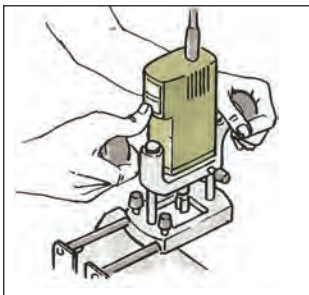

L For prolonged routing operations use dust extraction equipment, particularly with materials such as Medium Density Fibreboard (MDF). Alternatively use a powered respirator with a visor, which also acts as an eye protector.

M Never leave cutters lying where they can cause injury or be damaged against other tools. Always return cutters safely to a storage rack, wallet or case.

When routing:

N Before switching on, and between each operation, check that all locking knobs, nuts and screws are fully tightened. Check that anti-vibration springs are fitted to each locking

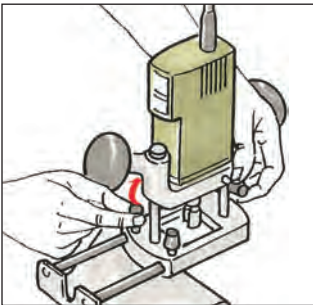

nut as per original specification and consider fitting them to those machines not supplied with them as standard.

O When cutting circles, do not allow the cable to twist excessively. Regularly switch off and unwind the cable in the reverse direction.

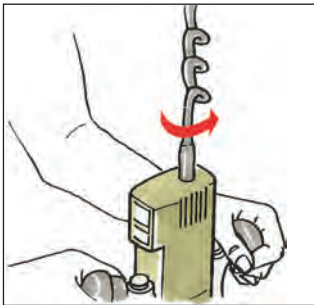

P Before making any adjustments, make sure the router has come to a complete stop and disconnect from the mains supply. Never leave the router running unattended.

Q Always feed the cutter into the material against the rotation of the cutter when using the router portably.

R If the cutter is protruding from the base of the router, i.e. fixed at a set cutting depth, do not switch the router on with the cutter in contact with the workpiece. When the operation has been completed, a simple stand can be used to avoid accidents while the cutter is still revolving.

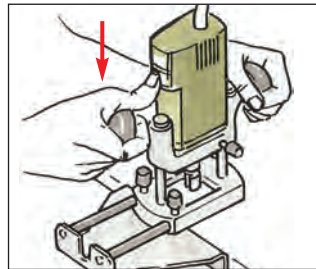

2

ROUTING BASICS

2.1 THE PLUNGE ROUTER



The modern plunge router is a precision tool that can perform a wide range of wood machining operations. With a powerful motor revolving the cutter at high speed, the machining quality is extremely precise and often requires no further finishing.

The router consists of the motor and its housing, sliding on spring columns fitted to a rigid base plate. The router cutter is fitted into a fixed diameter collet, directly mounted on the motor shaft. This arrangement allows the cutter to be plunged into the work at a precise 90° to the surface and having performed the machining operation, withdrawn safely above the base plate.

With cylindrical type routers, the body of the motor can be removed by releasing a body clamp. This allows the motor to be used portably for grinding and shaping with rasps, or for fitting it into an overhead stand. Larger, professional routers are not suitable for this purpose, but include a range of other important features.

Collet capacity

The shank of the cutter fits into a tapered collet and is secured by a collet nut. Smaller routers sold in the UK either accept a 6.35mm (1/4") or 8mm collet, with larger routers, a collet capacity of 6.35mm, 8mm and 9.5mm (3/8"), 12mm or 12.7mm (1/2") are available.

Hand grips

These allow the router to be guided with both hands along its intended path. On some routers, one grip handle has a dual role as it will release the plunging mechanism with a quarter turn. On others, a separate lever is provided for this purpose.

On/Off switch

This is usually positioned so that it is within easy reach without releasing your grip on the handles.

Depth of cut

A depth stop of varying designs is fitted to all plunging routers and limits the downward movement of the cutter, thus controlling the depth of cut. Certain routers have a three stage turret stop, allowing three depths of cut to be preset. The depth of cut can always be set by locking the plunge mechanism at any point along its travel. More professional routers have a fine adjuster included or available as an accessory. This can be used for very precise depth control.

Speed Control

Certain models of router are available with variable speed control, which allows a wide range of cutters to be used, on wood, plastics and soft-metals. All the cutters in the Starter Set should be used at maximum router speed.

Having purchased a new router, read the instruction book in order to fully understand your router's specific features.

2.2 STANDARD ACCESSORIES

With your new router you are likely to get several standard accessories. This may include:-

Side-fence

For routing parallel to any straight edge of the workpiece. This is attached by using two rods secured to the router base-plate. The width of a rebate or the distance in from the edge of the workpiece, can be adjusted by sliding and clamping the fence along the rods. Better quality fences are fitted with a fine adjuster for precision setting.

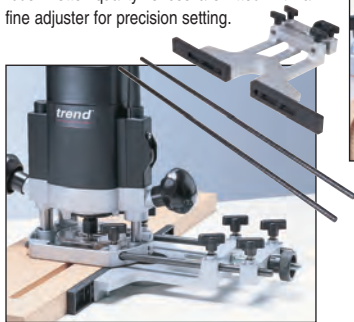

Beam Trammel

This is used for cutting arcs and circles and generally consists of a separate point that either screws beneath the base plate or is clamped onto a fence rod. Alternatively a bar can be inserted into the router base in place of one of the fence rods.



Guide Bush

For guiding the cutter around the edge of a pre-cut template or along a slot of similar width as the guide bush diameter. The guide bush itself, fitted flush into the base of the router, has a short flange concentric to the cutter. One size of bush is usually supplied with the router. Always allow a 2-3mm gap between the cutter and the inside of the guide bush.

Unibase

Enables routers with non-standard guide bush fittings to accept the range of Trend guide bushes. This moulded plastic sub-base will fit directly to most routers using the screws supplied.



2.3 ROUTER CUTTERS

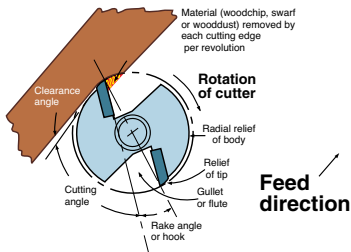

Geometry

The twelve cutters in the set have tungsten carbide tips brazed onto a steel body and are designed to cut natural timbers, plywood, MDF and chipboard. The clearance and cutting angles have been designed to leave a perfect finish. Cutters over 15.9mm diameter have been made to conform to the European EN847-1/2 safety standard.

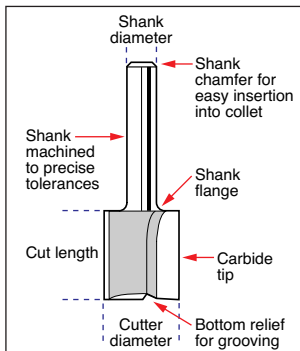

Feed Direction

When using the router, the direction that the cutter is fed into the wood must always be against the rotation of the cutter. This also ensures that the cutting action pulls the side-fence or guide bearing into the wood rather than allowing it to wander away.

Feed Speed

The optimum speed at which the cutter is fed into the wood must not be too fast that the motor slows down or too slow that the cutter leaves burn marks on the face of the wood. Practice judging the speed by listening to the sound of the motor.

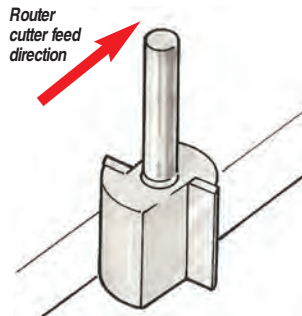

2.4 FITTING CUTTERS

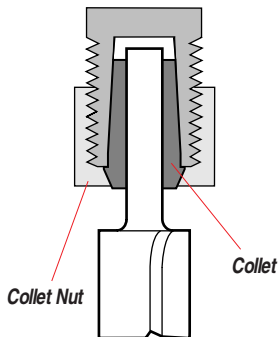

When fitting the cutter always ensure that at least 3/4 of the shank length is held in the collet. Do not try to grip the cutter by the end of the shank to gain extra cutting depth, as this can damage the shank and distort the collet itself. Working with the cutter held in this way can also prove dangerous to the operator as well as causing damage to the workpiece.

Do not push the cutter completely into the collet but allow 3mm between the collet and flange where the body of the cutter meets the shank. Also ensure that when fitting cutters that the end of the shank is not in contact with the internal face of the collet recess in the spindle.

Check that the collet nut thread is clean and ensure that they tighten without binding. Fit the collet and nut assembly before fitting the cutter and initially screw the collet nut up by hand. Finally, tighten using the spanner and spindle lock (or separate tommy bar or second spanner provided with the router), but do not over tighten.

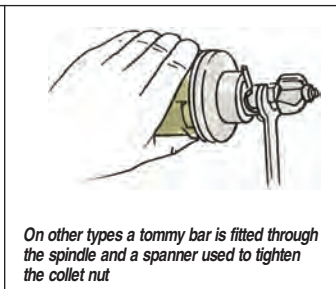
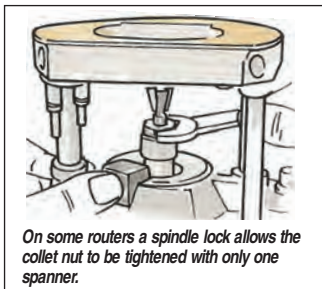

2.5 CUTTER TYPES

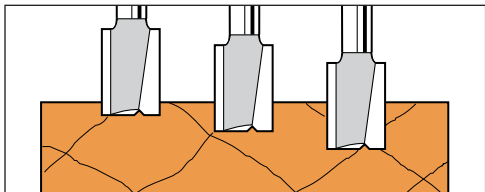

Groove forming cutters

These require the use of a side-fence, batten, guide bush or other method of guiding the router. To minimise heat build-up, side deflection, and allow waste material to clear easily, always cut in a series of shallow steps rather than to the full depth in one pass. With shaped cutters increasing depths of cut will often produce a different shape.

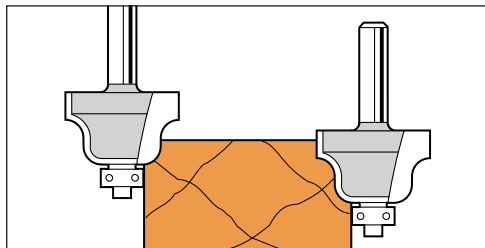
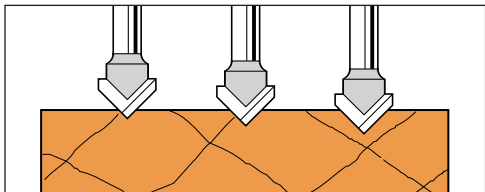

Self-guiding cutters

These cutters have a bearing guide that follows the edge of the workpiece or a template fitted beneath it. Self-guiding cutters can be used on both straight and curved edge work, for example on rectangular or circular tables. The bearing is fitted with a socket hex screw on a spigot machined into the nose of the cutter. The width of the cut is thus controlled by the edge of the bearing running along the workpiece.

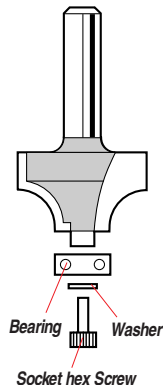

Bearing Washer

Socket hex Screw

www.trend-uk.com

SAFE ROUTING PROCEDURE

Sequence for Plunge Routing

- A. Fit the cutter into the collet of the router. See page 68.
- B. Set the depth of cut. See pages 82 & 83.
- C. Set-up guiding method. See pages 72.
- D. Check that the workpiece is secure & there are no obstacles.

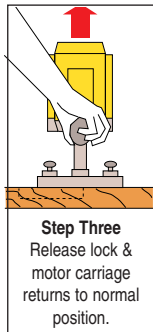
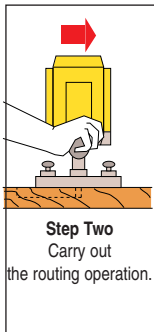
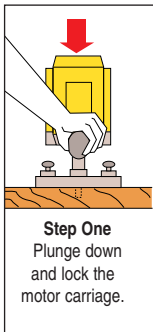

- G. Perform the routing operation.
- H. Retract the router cutter by releasing the plunge mechanism.
- I. Switch off and let the cutter come to a complete stop.
- J. Put the machine down and isolate from mains.

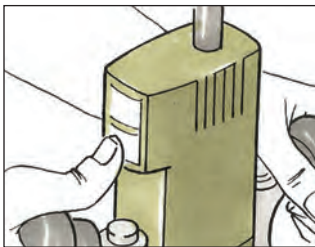

- E. Make sure router is not switched on and cutter is free to rotate. Only then connect to the mains and switch on.
- F. Allow motor to reach full running speed.

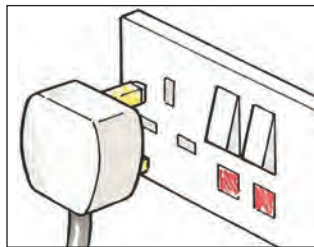

HOLDING THE WORK

Traditional G-cramps are now being replaced by 'quick action' clamps to hold the workpiece or jig etc in position. They are less likely to impede the path of the router and can be positioned in seconds. Sliding jaw benches fitted with adjustable bench stops are also ideal for this purpose, but ensure that the cutter does not touch the metal stops, or cut into the bench surface. If there is any risk of cutting down through the workpiece, or if this is intentional, lay a piece of thin waste material (i.e. hardboard) beneath the work to protect the bench.



In situations where clamps or other mechanical devices are impractical, pins, double sided tape or a hot melt glue gun can be used. When using either tape or glue, do ensure that the surfaces are first free of dust and grease.

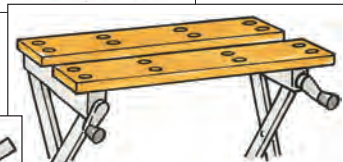
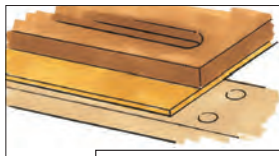
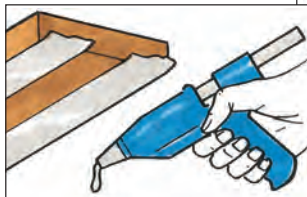

The MINIMACH is a portable clamping bed powered by any workshop vacuum extractor. It is a fast and simple obstruction free method of clamping when routing, sanding and sawing. The MINIMACH will hold sheet material between 95mm square and 1220mm square.



3

GUIDING THE ROUTER

SUMMARY OF METHODS



Using the router freehand

Guiding the router freehand to follow patterns or lettering.



Using a side-fence

Running the side-fence against the edge of the wood.



Using a guide batten

By running the router base against a straight edge clamped across the face of the work.

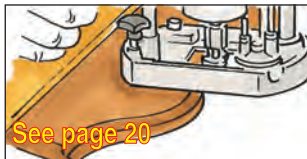

Using bearing guided cutters

By running the bearing guide of a self-guiding cutter against the edge.

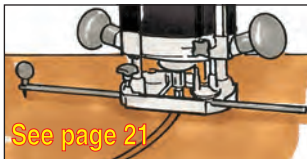

Using a beam trammel

By fitting a beam trammel for producing circles and arcs.



Using a guide bush and template

By fitting a guide bush and making a simple template.

FREE HAND ROUTING

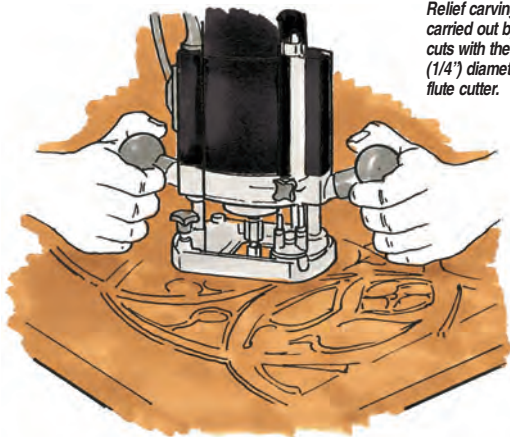

Relief carving can be carried out by taking light cuts with the 6.35mm (1/4") diameter straight flute cutter.

The small portable router is ideal for carrying out free-hand routing. First mark out on the material the pattern required. Engraving can be done with a 'V' groove, 6.35mm (1/4") diameter straight or small radiused cutter. Taking shallow passes will ensure there is complete control of the router. For increased control, guidance of the router can be made by holding the base of the router, with arms resting on the workpiece.



This book depicts various designs that can be copied and traced onto timber. The portable router can then be used to carve the design freehand.

USING THE SIDE-FENCE

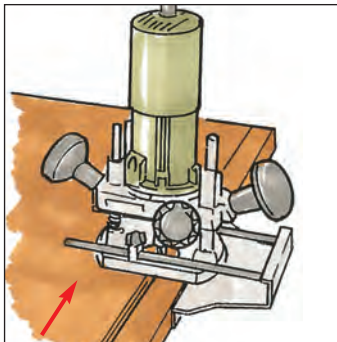
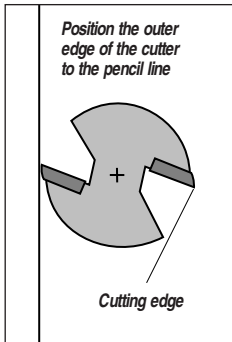
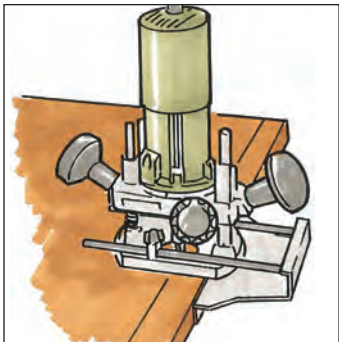

Adjusting the side-fence

The side fence is mounted by sliding it into the router base. Mount it against a parallel edge of the workpiece to rout a rebate or central groove. Adjust its position in from the edge of the workpiece, by sliding the rods through the base of the router. Position the router and side-fence onto the workpiece and adjust the fence until the edge of the cutter aligns with the correct position of the cut. Tighten up all the clamping knobs.

Routing with the side-fence

Turn the router on and position the router up to the edge of the workpiece. Then plunge the router in and cut the groove or the rebate.

When using the side-fence, keep it firmly against the edge of the workpiece and take care that it does not turn in at the start and finish of the edge. This can be achieved by putting extra pressure on the inside cheek of the side-fence.

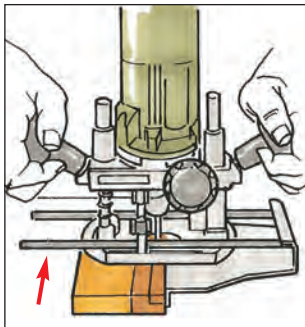

When rebating narrow sections, the material should be well secured. For router stability fix a piece of waste material, the same thickness, alongside the workpiece. This will prevent the router tipping. Always feed in the correct direction to ensure that the pull of the cutter keeps the side-fence pressing against the workpiece and not pulling away from it.

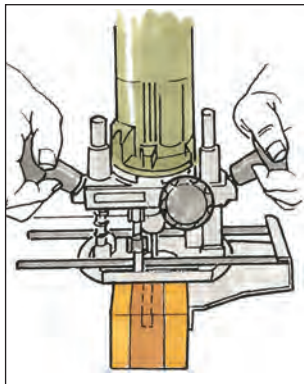

For very narrow sections, clamp extra material on both sides to give support to the router and prevent it from tipping. Often the use of a second side-fence on the opposite side will give extra support.

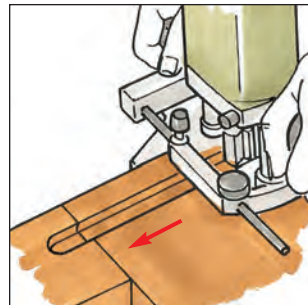

Although pressure on the inside cheek of the side-fence will prevent the router 'turning in', extra long wooden cheeks can be screwed to the face of the side-fence. Ideally clamp waste material at either end of the workpiece and carry the cut into them.

USING BATTEN GUIDES

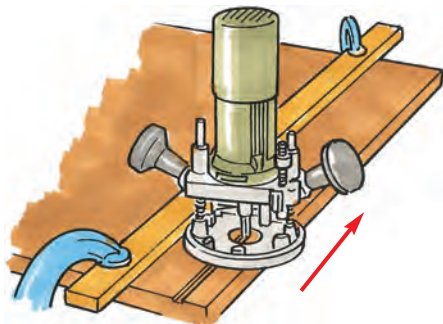

Using a batten to guide the router is very useful when:

- A. The edge of the workpiece is not parallel to the groove required.
- B. The edge of the workpiece is not suitable for guidance, e.g. has a poor finish.
- C. The groove is too far in from the edge and therefore the guide rods of the side-fence will not be long enough.

The battens should be the same length or longer than the groove required.

Guide battens should be clamped at each end, but ensure the clamps do not obstruct the router base. Always rout in the correct direction so that the cutter will pull against the batten. Always use the same point on the base to slide up against the batten, as often the base is not uniform in shape.

To cut a housing wider than the cutter, clamp two guide battens parallel with each other and position them to give the width of the groove required. Where stopped grooves are required such as for shelf supports, clamp a block at each end to prevent the router from over cutting.

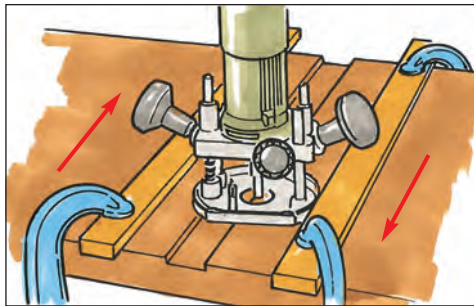

STUB MORTISE & TENON JOINTS

The Mortise: This is no more than a short groove and is routed with a straight flute cutter. The procedure is to mark the width and length of the mortise. Then set the side fence working from one edge. Make several passes until the depth required is achieved. For each depth setting make two cuts working from both sides of the timber in turn. This will ensure that the mortise is perfectly central. The corners of the mortise will need to be squared off with a sharp chisel.

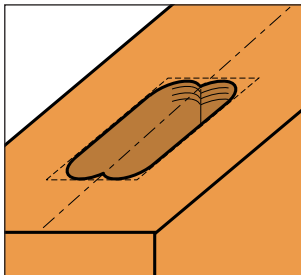

The Tenon: To make matching tenons, lay the timber sections side by side and cut all the shoulders simultaneously, using a clamped batten to guide the router. Now, remove the rest of the waste, by working with the router freehand. Rout the waste from the end of the tenons towards the initial groove. This will ensure there is adequate support for the base of the router and will prevent tipping. Turn all the components over, butt the cut shoulders against a batten

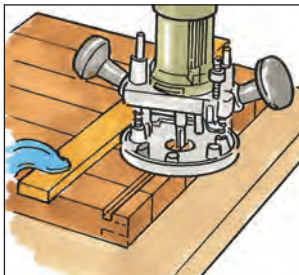

secured to the bench and repeat the process to complete the tenons.

Short shoulders on the tenon are best cut with a hand-saw.

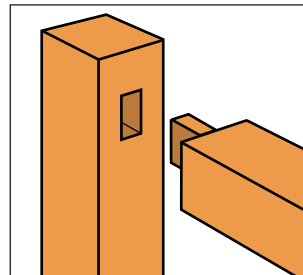

USING BEARING GUIDED CUTTERS

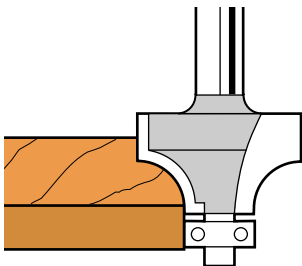

With bearing guided cutters, setting up is a much simpler operation. No fence or batten is required as the bearing on the cutter acts as the guide. A bearing guide also enables the edge of curved workpieces to be moulded. The edge of the workpiece must be free from imperfections as these will be reflected in the finish of the mould. Where the material thickness leaves insufficient room for the bearing to make contact, a second piece of material can be fixed beneath it for the bearing to follow.

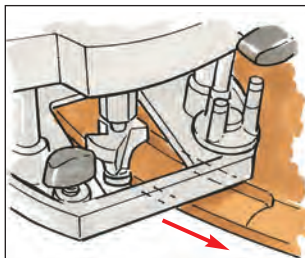

First set the depth of cut to give the required moulding.

When routing maintain constant feed speed against the rotation of the cutter throughout the pass and always feed against the rotation of the cutter, e.g. for external moulding, in an anti-clockwise direction.

With bearing guided cutters such as the rebater supplied in the set, take several passes by adjusting the depth between cuts by 2-3mm.

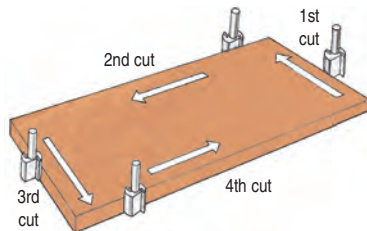

When moulding natural timbers always mould the end grain first, followed by the long grain. This ensures that if there is breakout, this will be removed when the long grain is routed.

When reaching the end of the workpiece, the cutter will have a tendency to 'route around the corner'. To prevent this, either fit the side-fence in line with the bearing (if routing straight edges), or rout into a waste piece of material. Once more, fitting elongated fence strips to the fence will be helpful.

USING THE BEAM TRAMMEL

The beam trammel is used for cutting arcs and circles and generally consists of a separate point that screws beneath the base plate, or it is clamped onto the end of the fence rod or a bar is held in the side-fence rod clamps. When cutting arcs into the edge of the workpiece, locate a centre point and position support strips close to the edge, on which to balance the router.

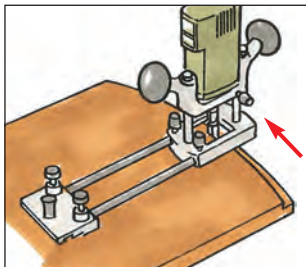

When cutting completely through the material, the centre piece will come loose as the last pass is made. To prevent it from contacting the cutter, secure it with double sided tape, as well as clamping the outer section before starting the operation.

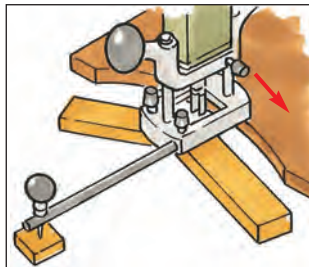

The point of the trammel is located in the centre of the circle by pressing the point into the workpiece. If you wish to avoid marking the work, fix a small pad of timber, with double sided tape at the centre on which to position the centre point.

To give extra security to prevent the point slipping out of the pivoting point, recess the tapered bolt deeper into the pad or workpiece.

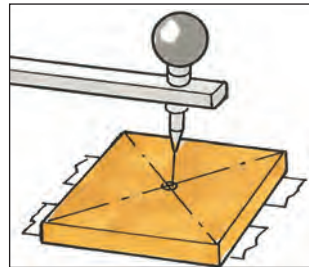

USING GUIDE BUSHES AND TEMPLATES

Guide bushes are available in different diameters to allow various diameter cutters to be accommodated. Choose a guide bush that allows at least 2 to 3mm clearance around the cutter to allow waste to clear. Templates should be cut from MDF or a hard material of a thickness slightly greater than the guide bush depth (i.e. for 5mm bush flange

projection, allow minimum 6mm thickness). When cutting out templates, ensure that the edges are smooth otherwise any irregularities will be repeated on the workpiece.

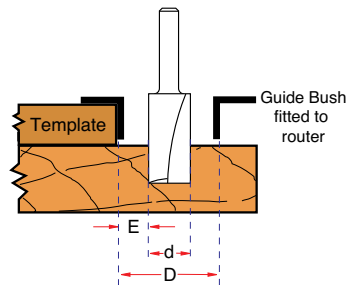
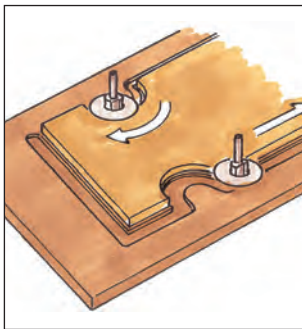
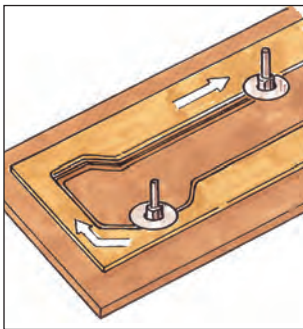

When drawing out the template shape, remember that the difference between the cutter and outside guide bush diameter needs to be allowed for. This margin (E) is calculated by deducting the cutter diameter (d) from the outer guide bush diameter (D) and dividing the remainder by two. ($E = (D-d) \div 2$). For external templates deduct this amount from each edge of the template or guide. For internal templates add this amount to each edge.

A guide bush is primarily used for guiding the cutter around the edge of a pre-cut template or along a purpose made slotted panel with a slot width to match the bush flange diameter. The guide bush itself, fitted flush into the base of the router, has a bush flange concentric to the cutter. This runs against the edge of the template or guide. When routing, follow the correct feed direction, depending on whether it is an internal or external template. Keep the bush flange tight up against the template and do not lift the router as it will cut into the template edge.

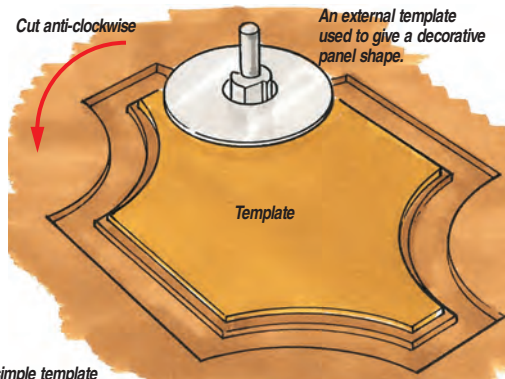
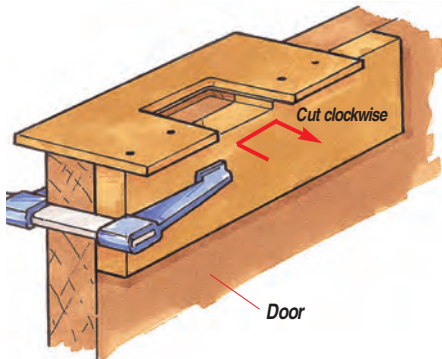

A simple template can be used for recessing hinges

A simple slot template cut into a tee-square can be used for cutting cross housings.

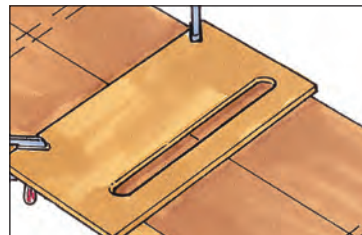

4

SETTING THE DEPTH OF CUT

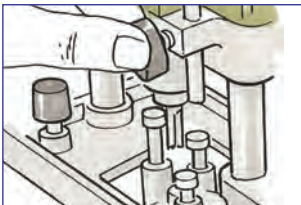

To set the required depth of cut (that is the full depth of the groove or rebate), most routers are fitted with a depth stop. On light duty routers, this is likely to be a simple graduated rod held in a clamp.

To set the depth of cut, fit the cutter and rest the router over the work. Release the plunge lock and lower the cutter until the tip rests on the work. Re-tighten the plunge lock.

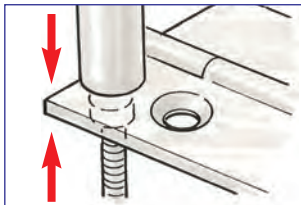

Drop the depth stop rod until it rests on the stop (usually the head of one of the turret stop screws). Raise the rod by an equal amount to achieve the depth of cut.

Alternatively, if you are recessing for a fitting such as a hinge, use the hinge flap itself, as a gauge to set the gap.

Many routers are also fitted with a three position turret stop. When cutting in several steps, this allows each depth to

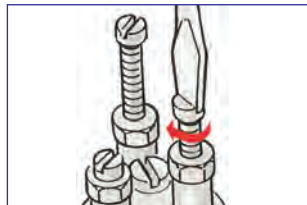

be pre-set and quickly selected on each consecutive pass.

When using the turret stop, set the depth of cut for the final pass (i.e. full depth) on the lowest screw and set the others at equal steps for the first two passes.

Using a three position turret stop

Once the turret stops are set up, the procedure for using them is as follows:

Step 1

Set the turret stops to equal steps (i.e. 3mm or as required). Lower the tip of cutter onto workface and set the depth rod to equal a distance of 3mm above highest stop.

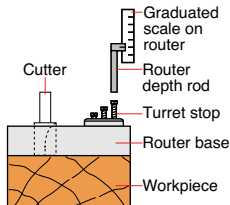

Step 2

Plunge cut to the first stop (3mm) and rout to complete cut to that depth.

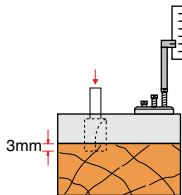

Step 3

Rotate turret to the centre stop and cut the work to that depth (i.e. 6mm total depth of cut).

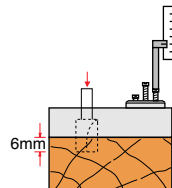

Step 4

Rotate turret to the lowest stop and cut the work to that depth (i.e. 9mm total depth of cut).

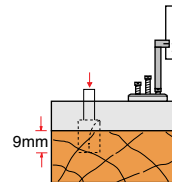

Step 5

To cut a further depth, set the cutter to the bottom of the cut, and retract the depth stop rod. Rotate the turret back to highest stop and set the rod to the required depth (i.e. 3mm). Repeat steps 2 to 4 until required depth of cut is reached.

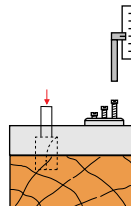

5 STRAIGHT CUTTERS

Straight cutters are generally used for trimming and cutting straight edges, cutting straight rebates, slots and grooves. For these operations the router is guided by the side fence or against a batten edge. Using a template or guide bush, they can also be used for similar operations on regular or irregular curved work.

They are also valuable for producing a range of joints.

Two straight cutters are provided in the Trend Starter Set. These are 6.3mm and 12.7mm diameter. Both are suitable for grooving and rebating. The 1/4" (6.35mm) cutter can be plunged in centrally away from the board edge.

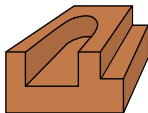
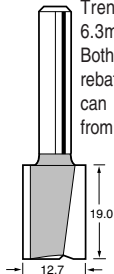

The 1/2" (12.7mm) cutter must enter from the edge of the board.

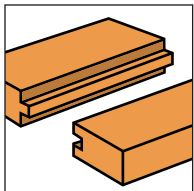
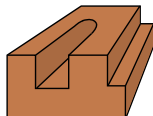
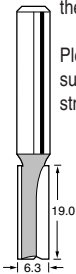

Tongue & groove joint

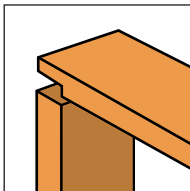

Lap joint

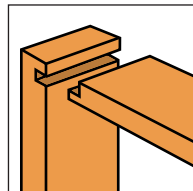

Barefaced tongue & groove joint

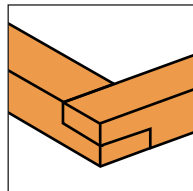

Halving joint

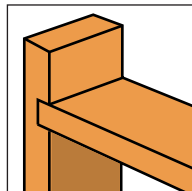

Housing joint

Tongue and groove joints

Use a straight cutter to rout a square tongue on the edge of a board. Cut a matching groove down the centre of the other component, using a wooden strip clamped to both sides to provide a wide flush surface to support the base of the router. See 'Using the side-fence' on page 74 for further information.

Rebated and grooved joints

Lap joints, barefaced housings and halving joints are all variations on a basic

theme. By clamping several components together flat on a bench you can cut any one of these joints using a straight cutter in a router run against a guide batten.

Helpful tips

Always resist the temptation to rout grooves and joints in one pass of the router, so take several shallow cuts. This will ensure a better finish is obtained and it will reduce the load on the router. Mounting a waste piece at the end of the components clamped ready for

machining, will ensure the end panel does not split out (the cut is carried through into the waste piece).

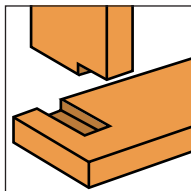

Stopped housing joint

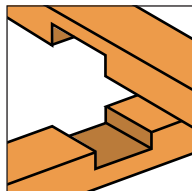

Cross halving joint

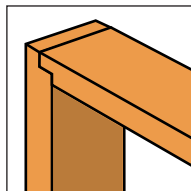

Rebated joint

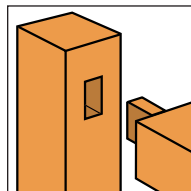

Stub mortise & tenon joint

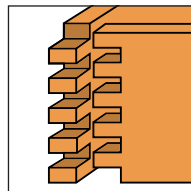

Comb joint

REBATE CUTTER

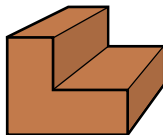
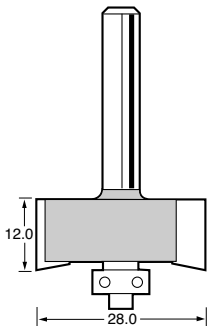

Self guiding rebate cutters can be used on straight as well as curved edges. Although the width of the rebate is set by the guide bearing diameter, different diameter bearings can be fitted to vary the rebate size.

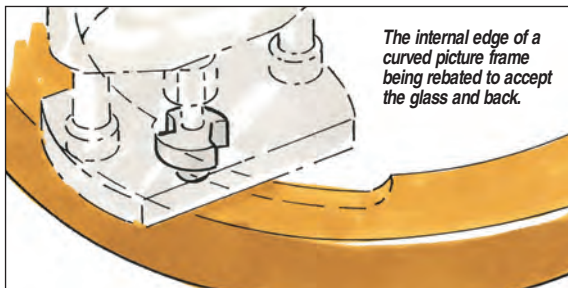

Bearing Ref.	Bearing Dia.	Rebate Width	Profiles shown 75%
B95A	9.5mm (3/8")	9.25mm	
B127A	12.7mm (1/2")	7.6mm	
B16A	15.9mm (5/8")	6.0mm	
B19A	19.1mm (3/4")	4.5mm	
N.B. Applicable to rebate cutter in Starter Set only			

OGEE MOULDING CUTTER

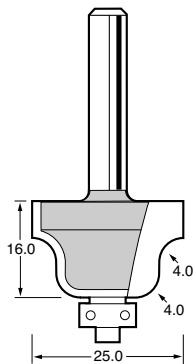

This is one of the most popular of the traditional decorative moulding cutters. The ogee cutter is suitable for finishing the edges of tables and cabinet tops as well as mirror and picture frames.

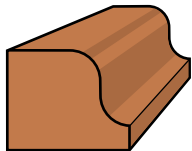
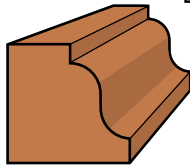
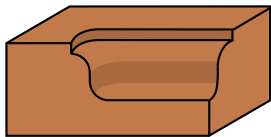

ROUNDING OVER CUTTERS

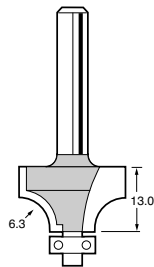
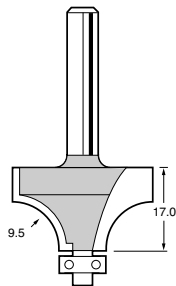

These are generally used to soften the appearance of square edged worktops, window boards and furniture. By lowering the cutter a top step can be routed. By performing a second pass on the reverse of the workpiece, a full bull-nose can be achieved.

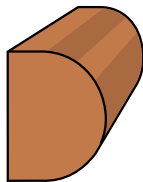
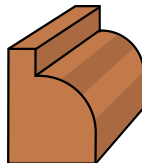
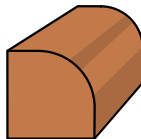

COVE CUTTERS

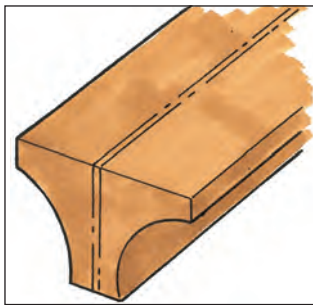
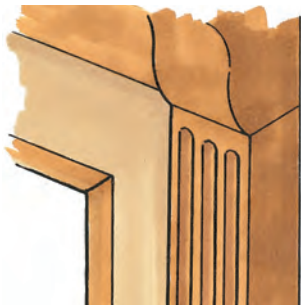
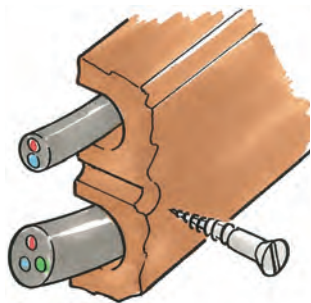
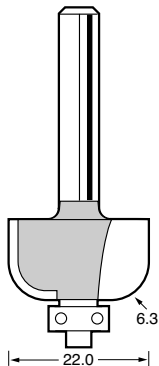
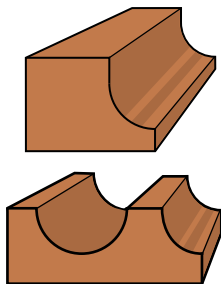
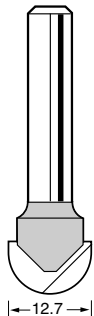

Generally used as decorative cutters, cove cutters can be used to rout a decorative edge finish, for fluting, or produce pipe and cable ducts. When producing small section cove beading, initially cut the moulding on both edges of a wide piece of timber prior to separating them by sawing along the centre. This allows the workpiece to be held safely.

DOVETAIL CUTTER

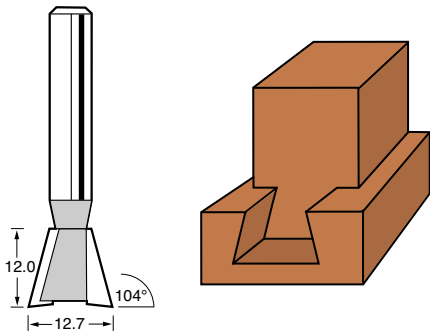

Although used for cutting housings for shelf ends, unlike straight cutters, the dovetail profile must be cut in one pass only. Always cut the housing before the dovetail tongue and adjust the tongue width to suit. For ease and safety, it is worthwhile considering using the router mounted in an inverted router table for cutting the tongues.

If a router below 750 watts is to be used, the load can be reduced by routing a relief cut with a straight cutter first in the centre of the area to receive the dovetail cut. This reduces the amount of material to be removed, reducing load on the router.

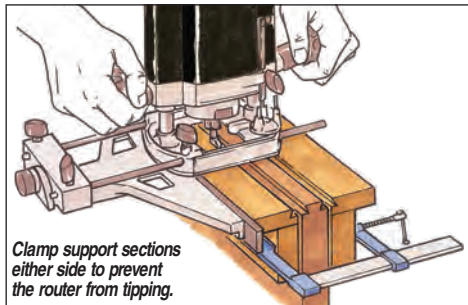
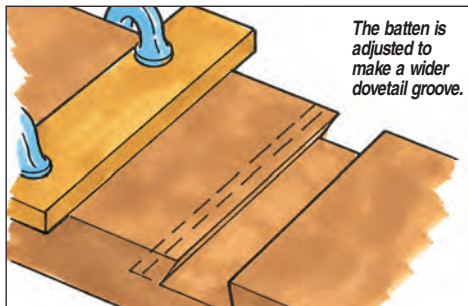

CHAMFER CUTTER

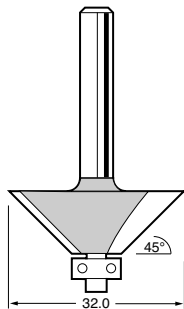

Chamfers can be run the full length of the workpiece or 'stopped' a short distance from the end. For the latter, a stop can be fitted to limit the router travel.

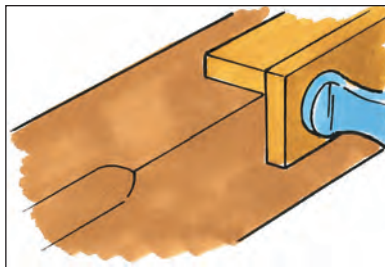
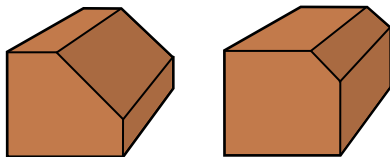

Chamfers can be used as a decorative edge on timber worktops, furniture legs and rails. They can also be used for removing the arris on posts and rail structures, such as fences, gates and garden furniture. When joining boards edge to edge, abutting edges can be chamfered to produce a vee-groove to disguise the glue joint.

V-GROOVE CUTTER

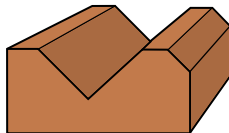
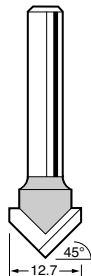

The main uses of the v-cutter are for decorative grooves, fluting, imitation matchlining on panel materials, and free-hand or template letter carving.

Light edge chamfering can also be carried out using this cutter, on both timber and laminates.

TRIMMING & TEMPLATE PROFILING CUTTER

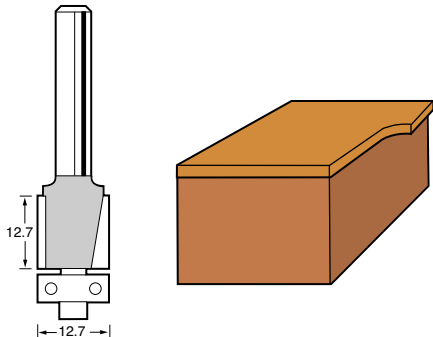

Bearing guided trimming cutters allow veneers and laminates to be trimmed flush with the edge of the base material, leaving a perfect chip free square edge. They can also be used to trim a thin workpiece flush to the edge contour of a pre-cut template.

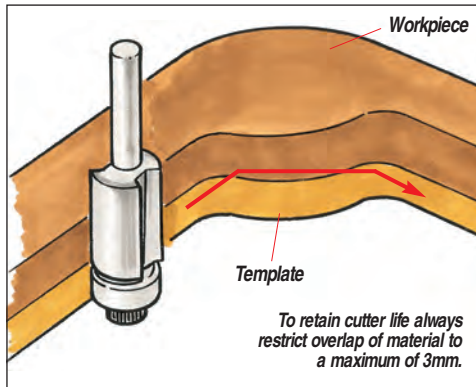
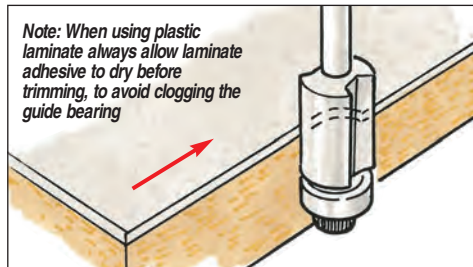

6

CUTTER AND COLLET MAINTENANCE



When honing bearing guided cutters always remove guide bearings to avoid flattening the rim.



Regular application of a dry lubricant spray will prevent resin build up.

www.trend-uk.com

It is essential to regularly maintain your cutters and collets in order to keep them in a safe and useable condition.

It will also help to maintain the life of your router by keeping the loads imposed upon it to a minimum.

Keeping your cutters sharp is a very simple operation requiring little skill and remembering a few basic rules.

Clean all resin deposits from the cutter with Rustbuster® or by scraping with a piece of stiff plastic before applying a dry lubricant spray such as Trendicote®.

Use a diamond sharpening stone to regularly hone your cutters, but only ever hone a router cutter on the flat underface of the cutting edge.



Brass brushes should be used to remove deposits from the inside of the collet.



Rustbuster® is used to lubricate the pillars of the router and to prevent surface corrosion.